

Product	Page No.
Panel Information	
Pro-Panel II Panel Profile	PPP-2
Panel Overview	PPP-2
Flashing Profiles	
Eave (Direct Fasten).....	PPP-3
Cleat	PPP-3
Box Gutter	PPP-3
Box Gutter End	PPP-3
Universal Gutter/Downspout Strap	PPP-3
6" x 4" Downspout	PPP-3
6" x 4" 95° Elbow	PPP-3
Downspout Bracket	PPP-3
Valley	PPP-3
Pro-Panel II Rake	PPP-3
Rakewall	PPP-3
Pitch Break	PPP-3
Peak	PPP-3
11" Ridge/Hip Cover	PPP-3
20" Ridge/Hip Cover.....	PPP-3
Vented Ridge Cover	PPP-4
Vent Drip.....	PPP-4
Pro-Panel II Inside Corner.....	PPP-4
Pro-Panel II Outside Corner	PPP-4
1.5" Sill/Head.....	PPP-4
1.5" Sill to Soffit	PPP-4
Head Jamb Cover.....	PPP-4
Pro-Panel II Jamb.....	PPP-4
1.25" Base	PPP-4
Gravel Stop.....	PPP-4
Accessory Profiles	
Pro-Panel II Closures	PPP-5
Universal Closure	PPP-5
Pro-Panel II Light Transmitting Panel.....	PPP-5
Tube Sealant	PPP-5
Tape Sealant.....	PPP-5
Rubber Roof Jack.....	PPP-5
Retro Roof Jack.....	PPP-5
Rubber Roof Flashing Kit	PPP-5
Touch-Up Paint.....	PPP-5
Continuous Ridge Vent.....	PPP-5
Pro-Panel II Panel Shear.....	PPP-5
Vent Material.....	PPP-5
Louver with Screen.....	PPP-5
Testing Information	
Section Properties and General Information	PPP-6
Design/Installation Considerations	
Fastener Installation Technique.....	PPP-7
Condition of Substructure.....	PPP-7
Fastening Information.....	PPP-8

Product	Page No.
Detail Conditions	
Eave Detail	PPP-9
Box Gutter Detail	PPP-9
Valley Detail.....	PPP-10
Rake Detail	PPP-10
Rakewall Detail.....	PPP-11
Endwall Detail.....	PPP-11
High Side Eave Detail.....	PPP-12
20" Ridge/Hip Detail	PPP-12
Ridge Detail.....	PPP-13
Gravel Stop Detail	PPP-13
Outside Corner Detail.....	PPP-14
Inside Corner Detail.....	PPP-14
Jamb Detail.....	PPP-15
Head Detail.....	PPP-15
Base Detail	PPP-16
Notes	
Notes	PPP-16

PRO-PANEL II® PANEL OVERVIEW

PANEL PROFILE

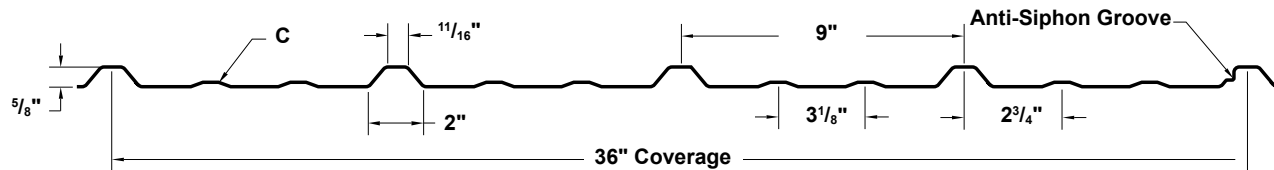

SLOPE

The minimum recommended slope for any Pro-Panel II roofing panel is 3:12.

SUBSTRATE

Pro-Panel II is designed to be utilized over open structural framing, but can easily be used with a solid substrate. The recommended substrate is $\frac{5}{8}$ " plywood with a 30 pound felt moisture barrier. To avoid panel distortion, use a properly aligned and uniform substructure.

COVERAGE

Pro-Panel II panels are available in a 36" width with a $\frac{5}{8}$ " rib height.

LENGTH

Lengths under 5'-0" are available with some cutting restrictions. Maximum recommended panel length is 45'-0". Longer panels require additional consideration in packaging, shipping, and erection. Please consult your Metal Sales branch for recommendations (see PGI-2 and PGI-3 for locations).

AVAILABILITY

Pro-Panel II panels are available in 26 gauge.

APPLICATION

Commercial and Industrial panel.

PERFORMANCE TEST

UL 2218, UL 790, Miami-Dade County Approved, Texas Department of Insurance

FASTENING SYSTEM

Direct Fasten (Exposed)

FASTENERS

The fastener selection guide should be consulted for choosing proper fasteners for specific applications. Quantity and type of fastener must meet necessary loading and code requirements (see PGI-12-14).

MATERIALS

Steel grade 50 per ASTM A-792
Steel grade 80 per ASTM A-792 or ASTM A-653

FINISH

- ▶ *Acrylic Coated Galvalume® (ACG) / ASTM A-792 - AZ55
- ▶ Prepainted Galvalume / ASTM A-792 - AZ50
- ▶ MS Colorfast45®
- ▶ **Fluorocarbon (PVDF)
 - * Differential appearance of Acrylic Coated Galvalume roofing materials is not a cause for rejection.
 - ** Meets both Kynar 500 and Hylar 5000 specifications.

EAVE (DIRECT FASTEN)

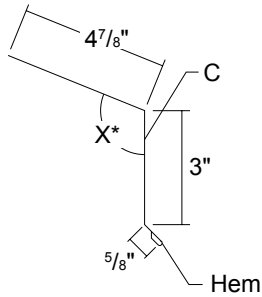

Length 10'-2" - *Specify Slope Angle

CLEAT

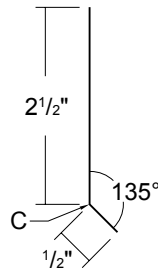

Length 10'-2"

BOX GUTTER

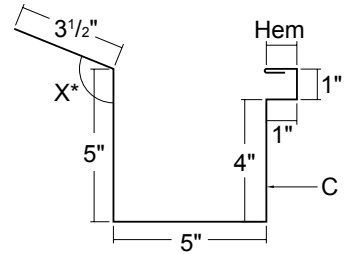

Length 10'-2", 20'-3" - *Specify Slope Angle

BOX GUTTER END

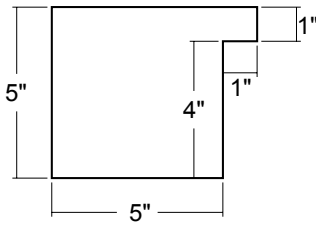

UNIVERSAL GUTTER/ DOWNSPOUT BRACKET

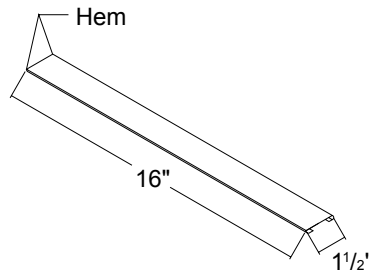

DOWNSPOUT 6" x 4"

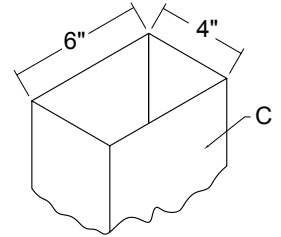

Length 10'-2", 20'-3"
(Also available 4" x 3 1/2")

95° ELBOW 6" x 4"

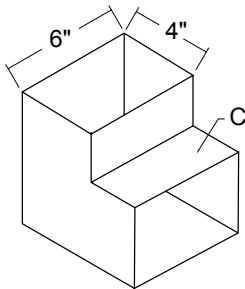

(Also available 4" x 3 1/2")

DOWNSPOUT BRACKET

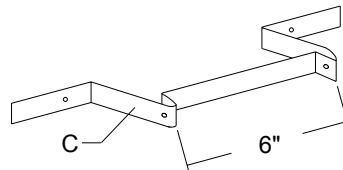

(Also available 4")

VALLEY

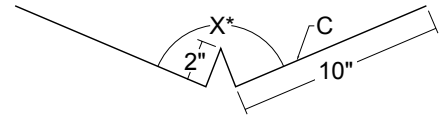

Length 10'-2", 20'-3" - *Specify Slope Angle

PRO-PANEL II RAKE

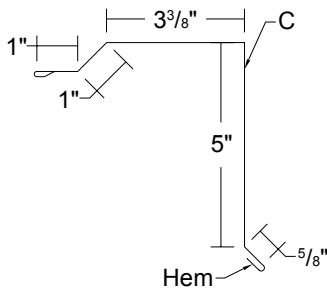

Length 10'-2", 20'-3"

RAKEWALL

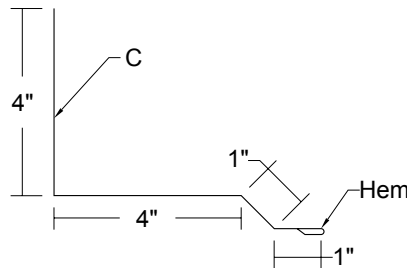

Length 10'-2"

PITCH BREAK

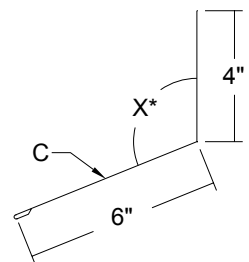

Length 10'-2" - *Specify Slope Angle

PEAK

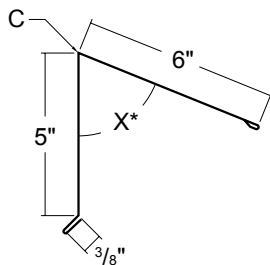

Length 10'-2", 20'-3" - *Specify Slope Angle

11" RIDGE/HIP COVER

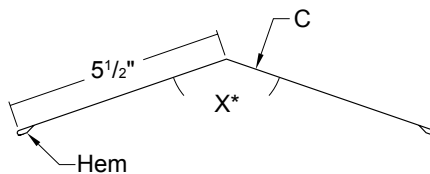

Length 10'-2", 20'-3" - *Specify Slope Angle

20" RIDGE/HIP COVER

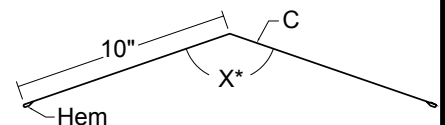

Length 10'-2", 20'-3" - *Specify Slope Angle

PRO-PANEL II® FLASHING PROFILES (CONT.)

VENTED RIDGE COVER

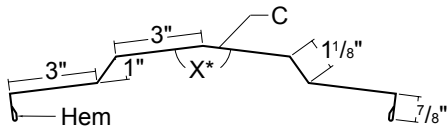

Length 10'-2", 20'-3" - *Specify Slope Angle

VENT DRIP

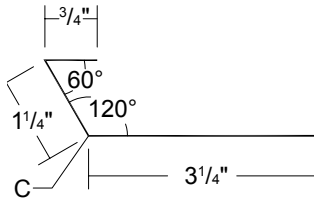

Length 10'-2"

PRO-PANEL II INSIDE CORNER

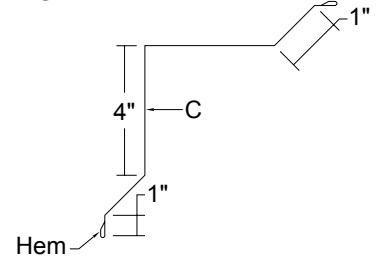

Length 10'-2", 14'-2", 20'-3"

PRO-PANEL II OUTSIDE CORNER

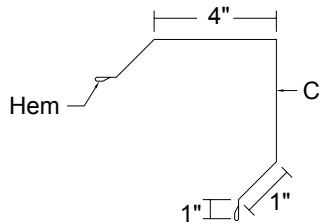

Length 10'-2", 14'-2", 20'-3"

1.5" SILL/HEAD

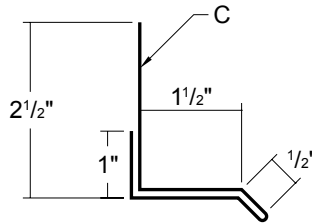

Length 10'-2"

1.5" SILL TO SOFFIT

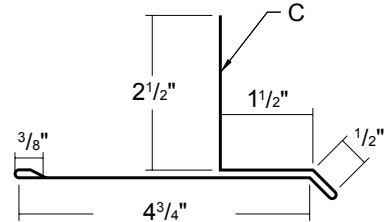

Length 10'-2"

HEAD JAMB COVER

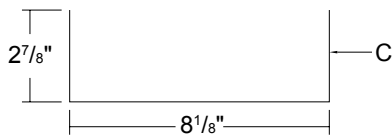

Length 10'-2", 14'-2"

PRO-PANEL II JAMB

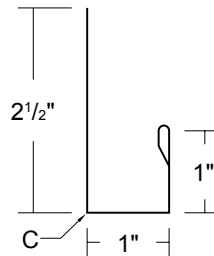

Length 10'-2"

1.25" BASE

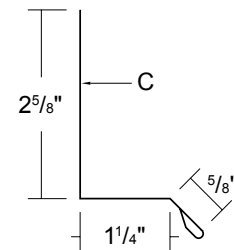

Length 10'-2"

GRAVEL STOP

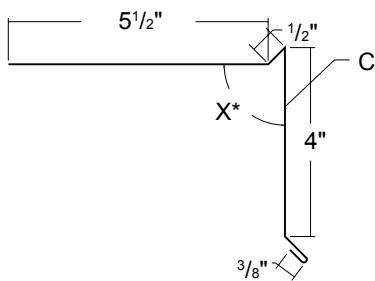

Length 10'-2" - *Specify Slope Angle

C- Indicates color side of flashing.

PRO-PANEL II CLOSURES



Outside Closure



Inside Closure

Polyethylene Foam

UNIVERSAL CLOSURE

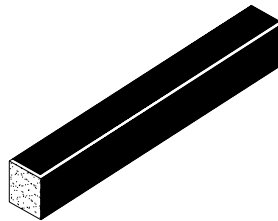

1" x 1 1/2" x 50' Polyethylene Foam
1" x 1 1/2" x 10' Polyethylene Foam

PRO-PANEL II LIGHT TRANSMITTING PANEL

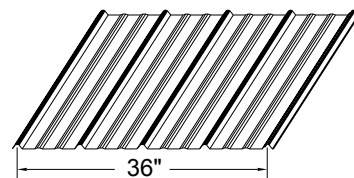

5 Ounce White Fiberglass
Available In 10' and 12' Panels

TUBE SEALANT

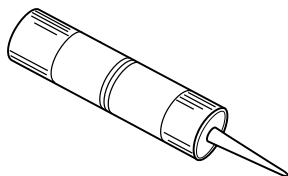

10.3 oz. Cartridge
Urethane

TAPE SEALANT

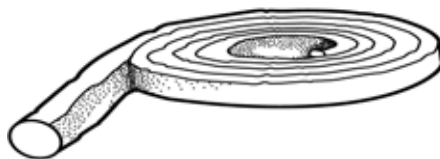

3/8" X 3/32" X 50'
Single Bead
Butyl - Gray

RUBBER ROOF JACK

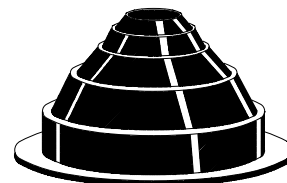

MINI (1/4" to 1 1/8" O.D. Pipe)
#2 (1 3/4" to 3" O.D. Pipe)
#4 (3" to 6" O.D. Pipe)
#6 (6" to 9" O.D. Pipe)
#8 (7" to 13" O.D. Pipe)

RETRO ROOF JACK

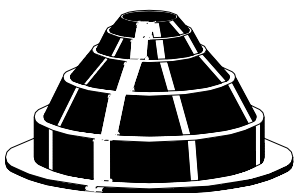

#801_{RETRO} (3/4" to 2 3/4" O.D. Pipe)
#802_{RETRO} (2" to 7 1/4" O.D. Pipe)
#803_{RETRO} (3 1/4" to 10" O.D. Pipe)

RUBBER ROOF FLASH KIT

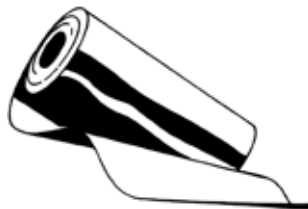

12" x 50'-0" Flash Kit
18" x 50'-0" Flash Kit

TOUCH-UP PAINT

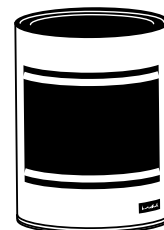

Available in pints
PVDF / MS Colorfast45

CONTINUOUS RIDGE VENT

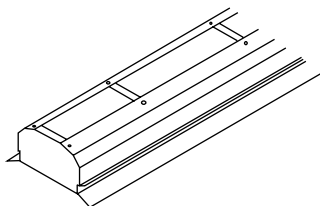

9" x 10', 12" x 10'

PRO-PANEL II PANEL SHEAR

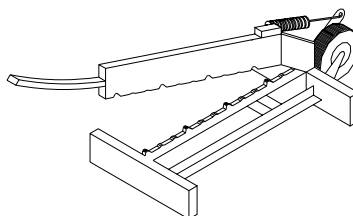

VENT MATERIAL

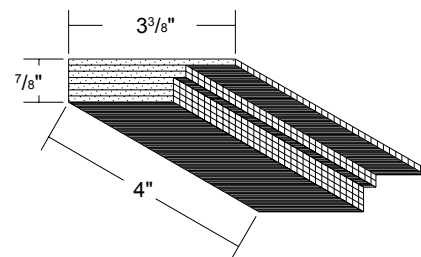

LOUVRE WITH SCREEN

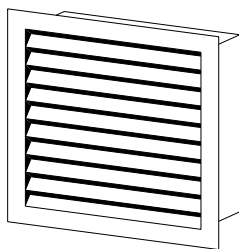

3' x 3' or 3' x 4'

PRO-PANEL II® SECTION PROPERTIES AND LOAD TABLES

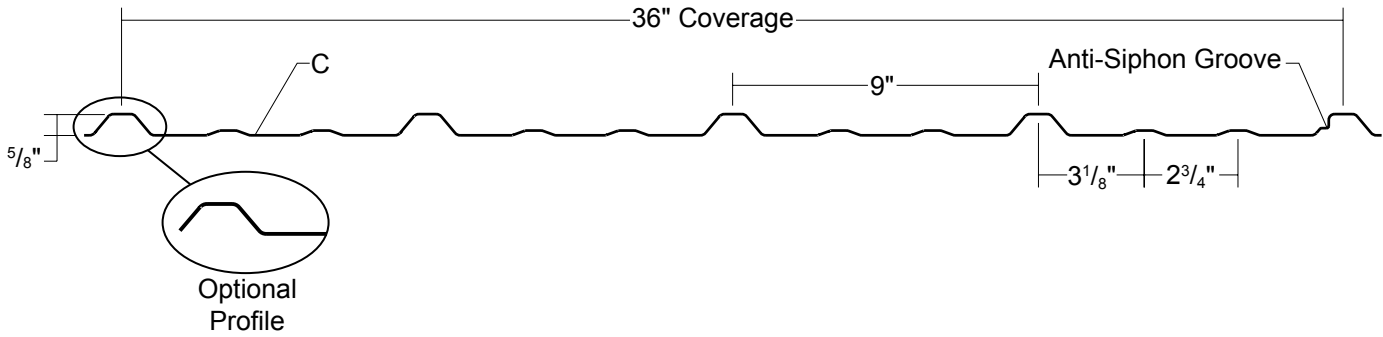

SECTION PROPERTIES								ALLOWABLE UNIFORM LOADS PSF (3 or More Equal Spans)											
Ga.	Width (in.)	Yield KSI	Weight PSF	Top in Compression		Bottom in Compression		Inward Load					Outward Load						
				I _{xx} In ⁴ /ft	S _{xx} In ³ /ft	I _{xx} In ⁴ /ft	S _{xx} In ³ /ft	2'	2.5'	3'	3.5'	4'	5'	2'	2.5'	3'	3.5'	4'	5'
29	36"	80	0.71	0.0067	0.0134	0.0047	0.0133	90	58	41	27	18	9	90	59	41	27	18	9
26	36"	80	0.87	0.0090	0.0181	0.0063	0.0170	115	75	52	35	23	12	122	79	55	35	23	12

- Theoretical section properties have been calculated per AISI 2001 "Specification for the Design of Cold-Formed Steel Structural Members." I_{xx} and S_{xx} are effective section properties for deflection and bending.
- Allowable load is calculated in accordance with AISI 2001 specifications considering bending, shear, combined bending and shear and deflection. Allowable load considers the worst case of 3 or 4 equal span conditions. Allowable load does not address web crippling or fastener/support connection and panel weight is not considered.
- Deflection consideration is limited by a maximum deflection ratio of L/180 of span.
- Allowable loads do not include a 1/3 stress increase in uplift.
- Diaphragm 306 plf average Ultimate Shear Strength using the above fastening pattern on 2x supports located 2' on center per ASTM E455-04

ATTACHMENT DETAIL

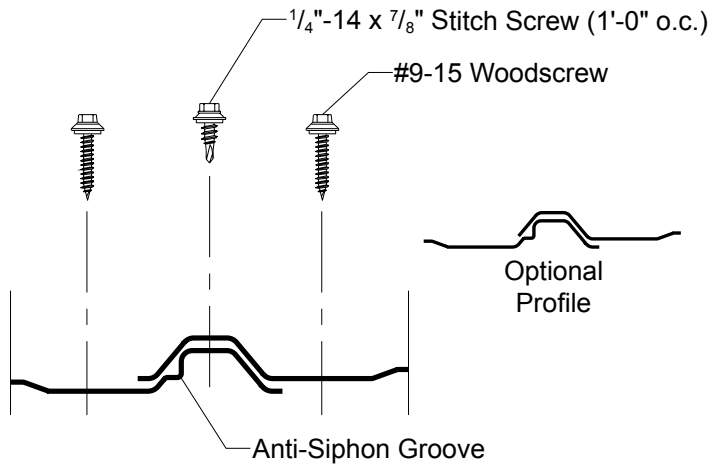

FASTENING PATTERN

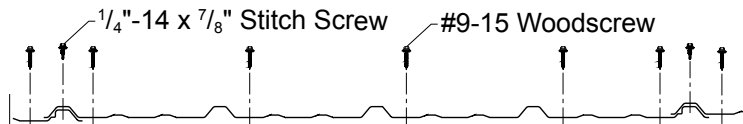

GENERAL INFORMATION

- Slope**
 The minimum recommended slope for Pro-Panel II® roof panel is 3:12.
- Substructure**
 Pro-Panel II® is designed to be utilized over open structural framing, or a solid substrate. To avoid panel distortion, use a properly aligned and uniform substructure.
- Coverage**
 Pro-Panel II® panels are available in a 5/8" rib height with a coverage width of 36".
- Length**
 Minimum factory cut length is 5'-0". Maximum recommended panel length is 45'-0". Longer panels require additional consideration in packaging, shipping, and erection. Please consult Metal Sales for recommendations.
- Fasteners**
 The fastener selection guide should be consulted for choosing the proper fastener for specific applications. Quantity and type of fastener must meet necessary loading and code requirements.
NOTE: All panels are subject to surface distortion due to improperly applied fasteners. Overdriven fasteners will cause stress and induce oil canning across the face of the panel at or near the point of attachment.
- Availability**
 Finishes: Acrylic Coated Galvalume® or MS Colorfast45®
 Gauges: 26 ga and 29 ga standard

FASTENER INSTALLATION TECHNIQUE

Recommended Tool Type - Use depth locating nose or adjustable clutch on screw gun to prevent overdrilling and strip out. **Do not use impact tools or runners.**

Seating the washer - Apply sufficient torque to seat the washer - do not overdrive the fastener.

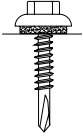
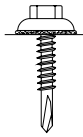
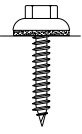
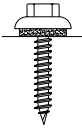
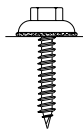
	CORRECT Sealing material slightly visible at edge of metal washer. Assembly is watertight.	TOO LOOSE Sealing material is not visible; not enough compression to seal properly.	TOO TIGHT Metal washer deformed; sealing material pressed beyond washer edge.
SELF DRILLER			
WOODSCREW			

To prevent wobbling - Make sure fastener head is completely engaged in the socket. If the head does not go all the way in the socket - tap the magnet deeper into the socket to allow full head engagement. Metal chips will build up from drilling and should be removed from time to time.

Protect drill point - Push only hard enough on the screw gun to engage clutch. This prevents excess friction and burn out of the drill point. Correct pressure will allow screw to drill and tap without binding.

Drilling through sheet and insulation - Ease up on pressure when drilling through insulation to avoid striking the purlin or girt with the point - apply more pressure after drill point contacts purlin or girt.

Drilling through purlin overlaps - Drilling through lapped purlins requires extra care. Excessive voids between purlins sometimes damages drill points and two self-drillers might be necessary to complete the operation. It is sometimes advantageous to predrill.

CONDITION OF SUBSTRUCTURE

Whether over solid substrate or open structural framing, panel distortion may occur if not applied over properly aligned and uniform substructure.

The installer should check the roof deck for squareness before installing Pro-Panel II panels. Several methods can be used to verify squareness of the structure for proper installation of the panels.

METHOD "A" - One method for checking the roof for squareness is to measure diagonally across one slope of the roof from similar points at the ridge and eave and obtain the same dimension.

METHOD "B" - The 3-4-5 triangle system may also be used. To use this system measure a point from the corner along the edge of the roof at a module of three (3). Measure a point from the same corner along another edge at a module of four (4). Then by measuring diagonally between the two points established, the dimension should be exactly a module of five (5) to have a square corner. Multiple uses of this system may be required to determine building squareness. If the endwall cannot be made square, the roof system cannot be installed as shown in these instructions.

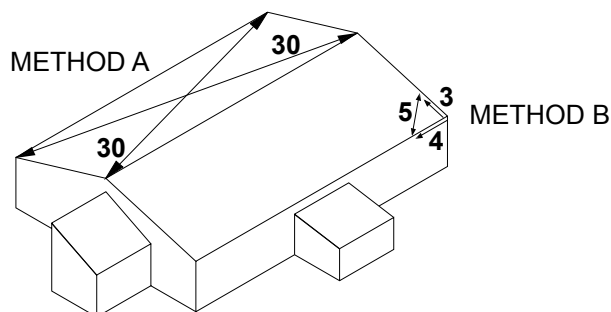

PRO-PANEL II FASTENING PATTERNS

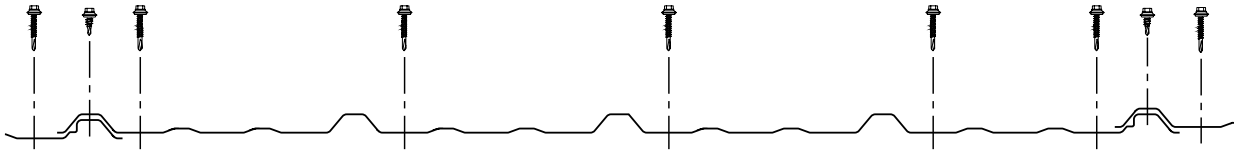
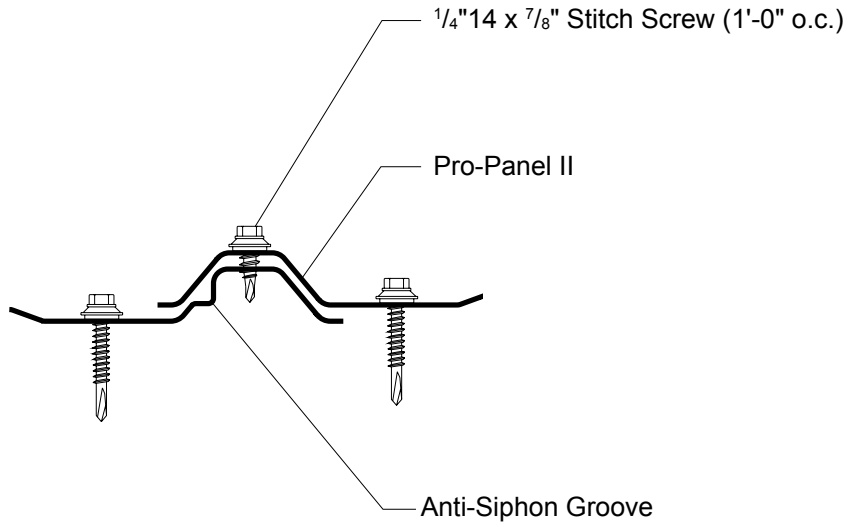

Pro-Panel II Fastening Pattern - Interior

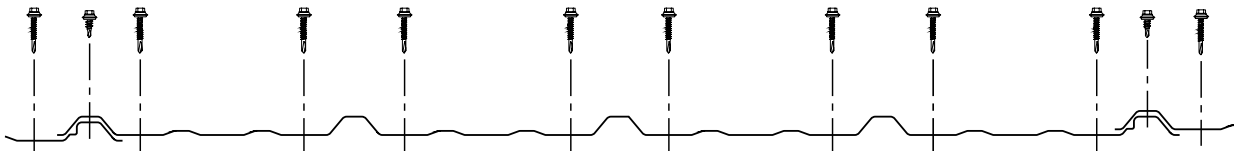

Pro-Panel II Fastening Pattern - Ends

PRO-PANEL II® EAVE DETAIL

3:12 Slope
Minimum

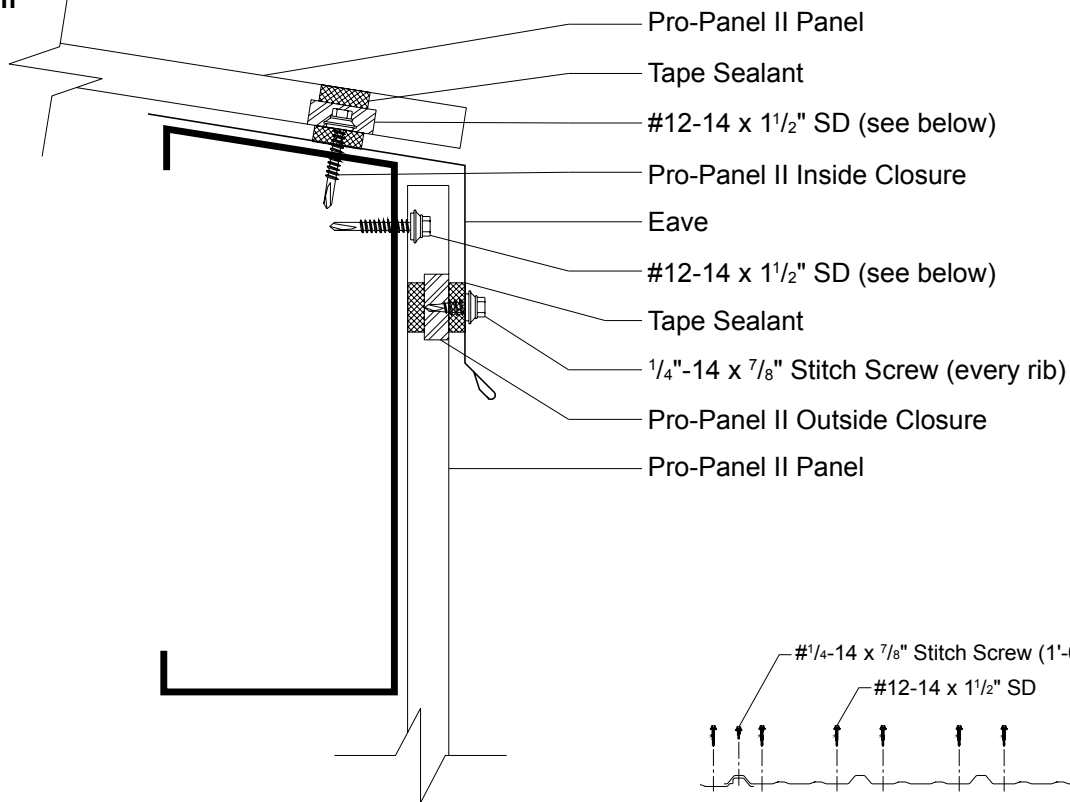

Pro-Panel II Fastening Pattern

PRO-PANEL II BOX GUTTER DETAIL

3:12 Slope
Minimum

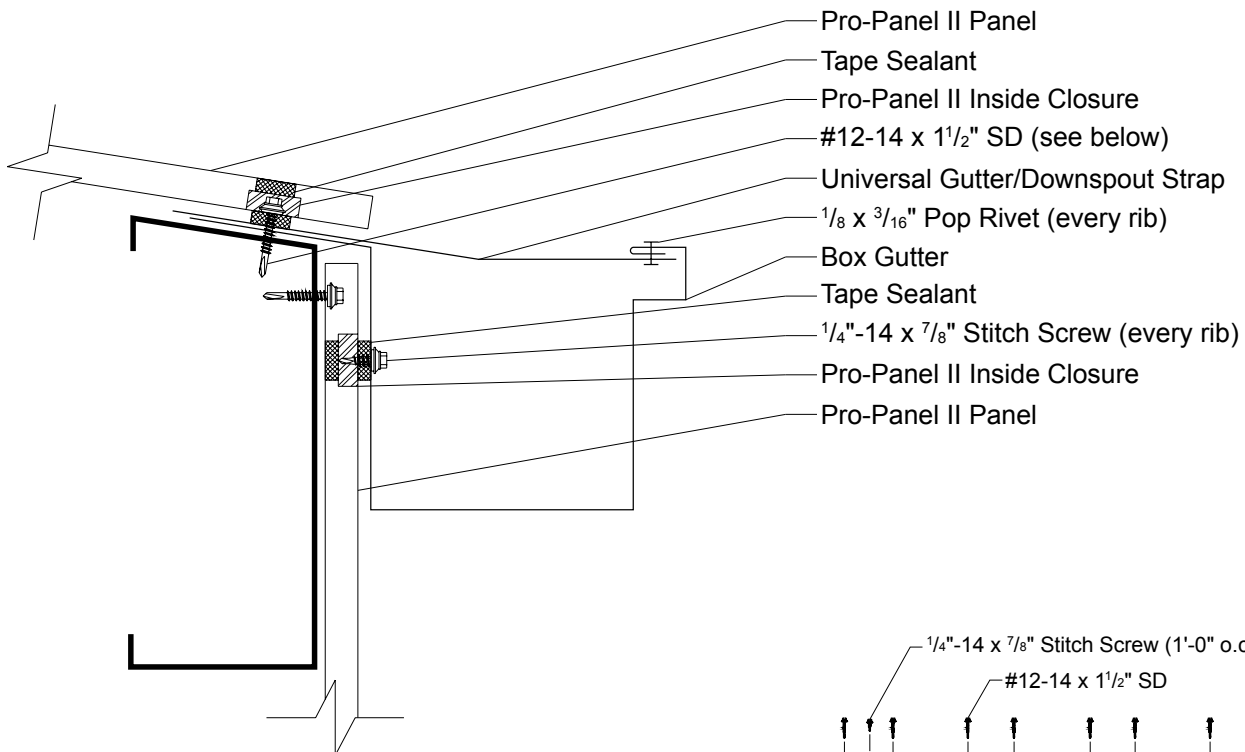

Pro-Panel II Fastening Pattern

PRO-PANEL II® VALLEY DETAIL

3:12 Slope
Minimum

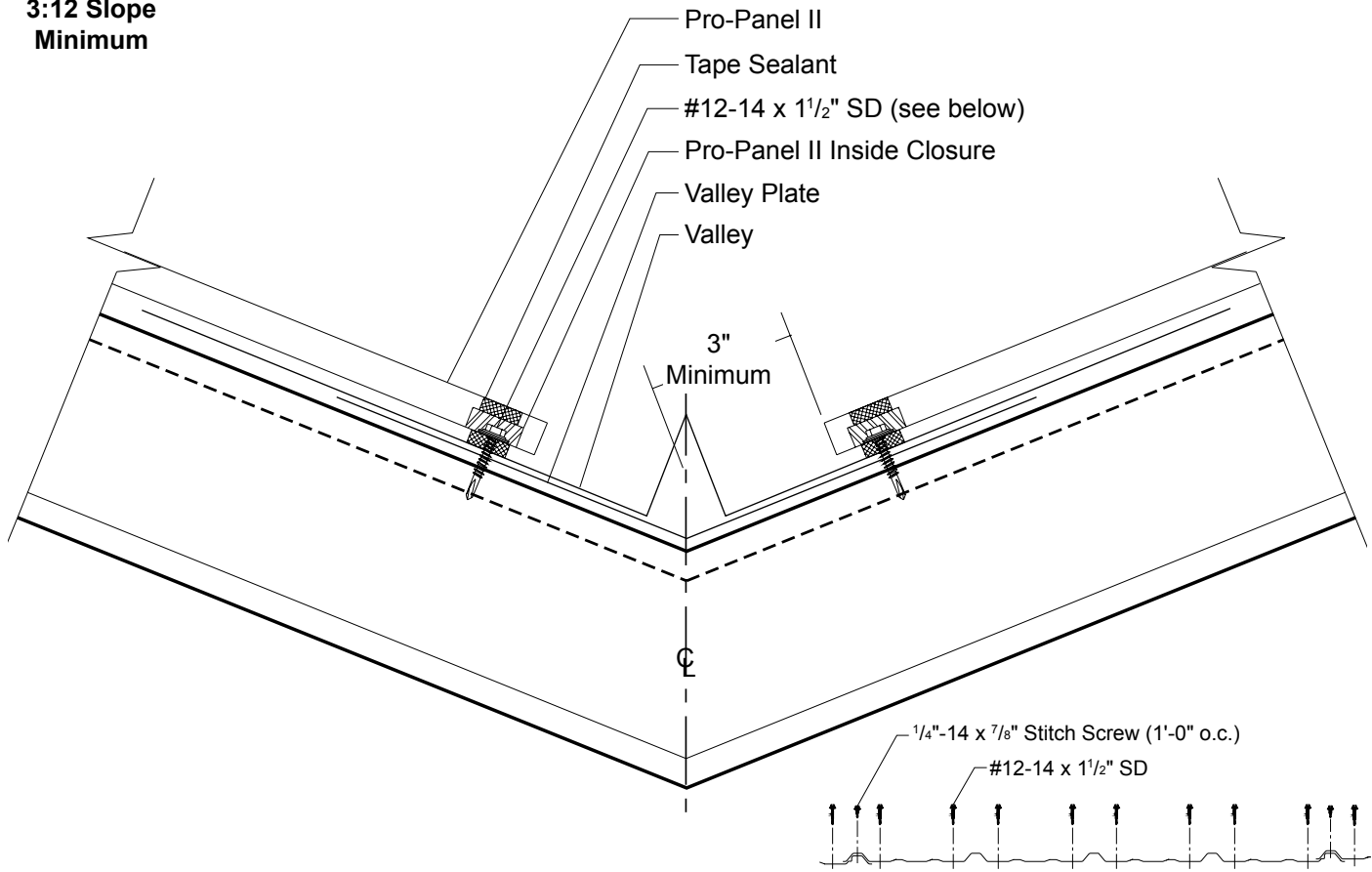

Pro-Panel II Fastening Pattern

PRO-PANEL II RAKE DETAIL

3:12 Slope
Minimum

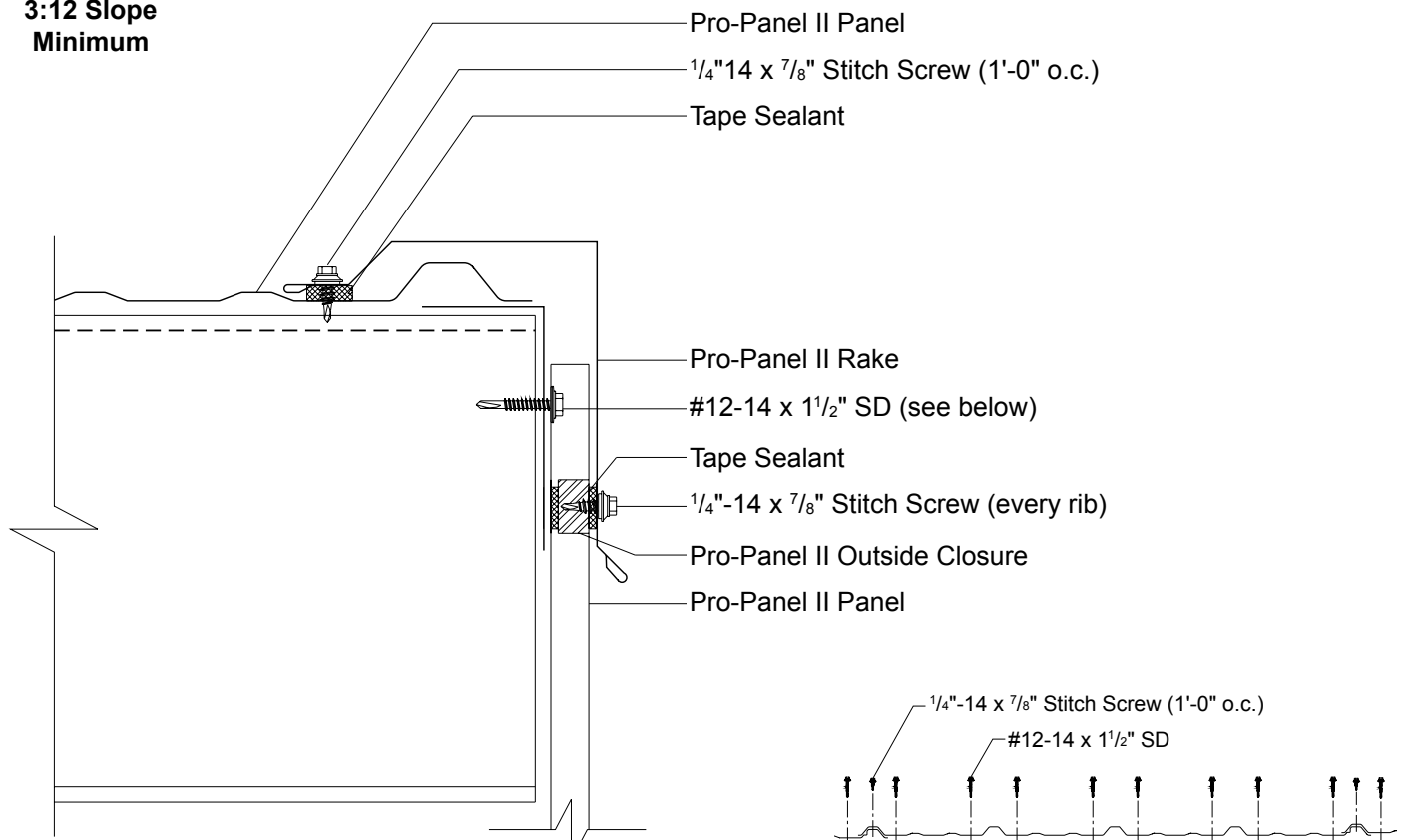

Pro-Panel II Fastening Pattern

PRO-PANEL II® RAKEWALL DETAIL

3:12 Slope
Minimum

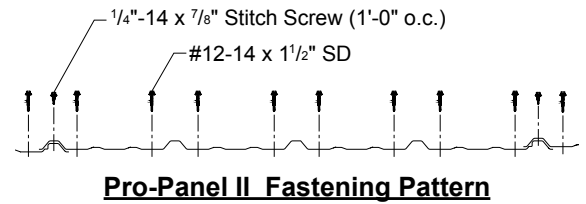
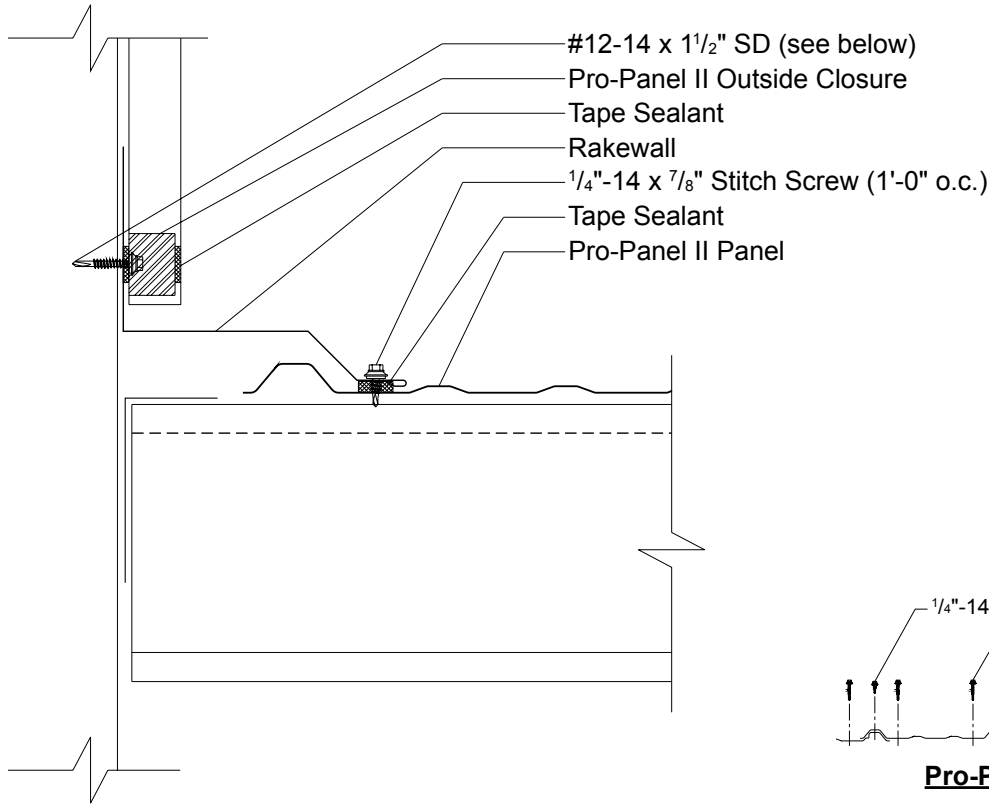

PRO-PANEL II ENDWALL DETAIL

3:12 Slope
Minimum

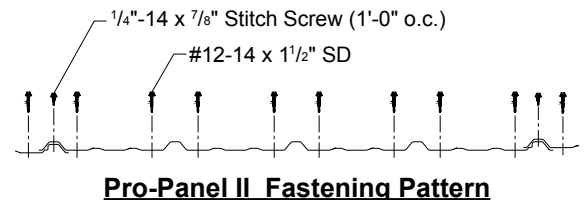
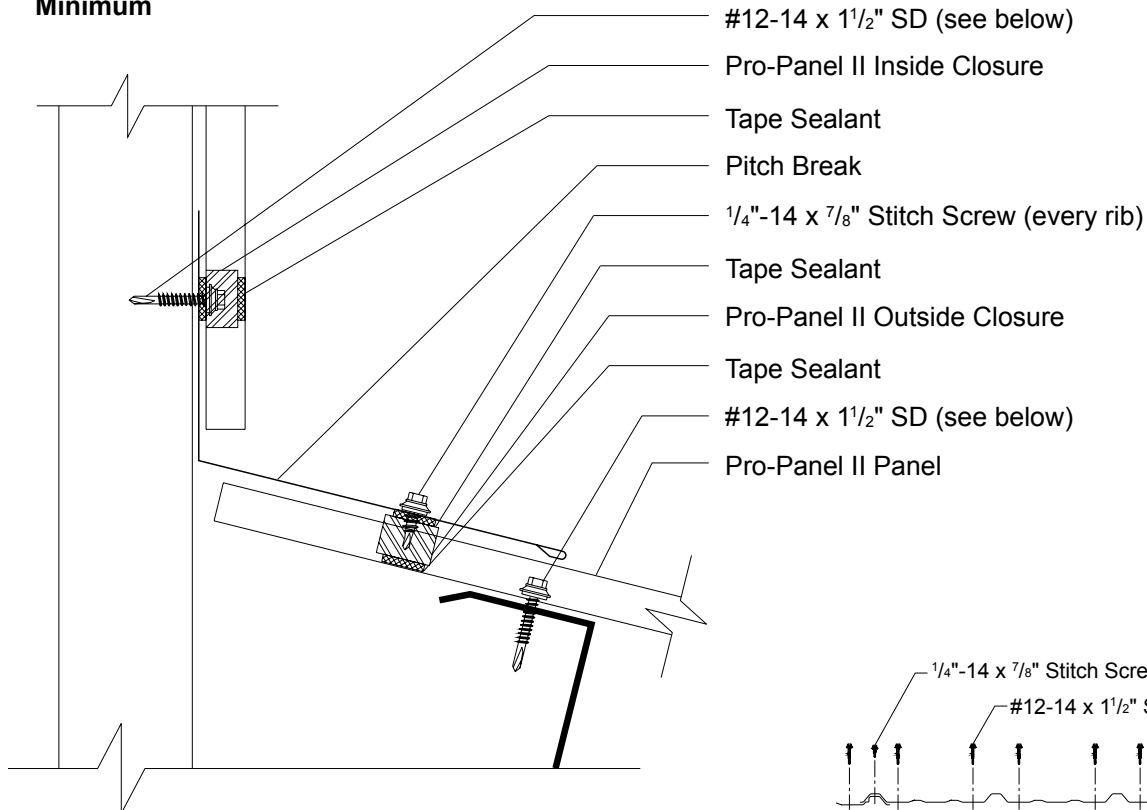

PRO-PANEL II® HIGH SIDE EAVE DETAIL

3:12 Slope
Minimum

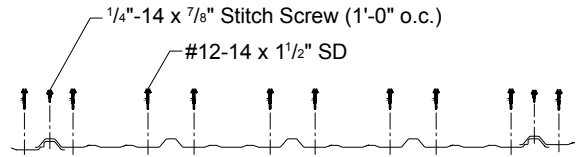
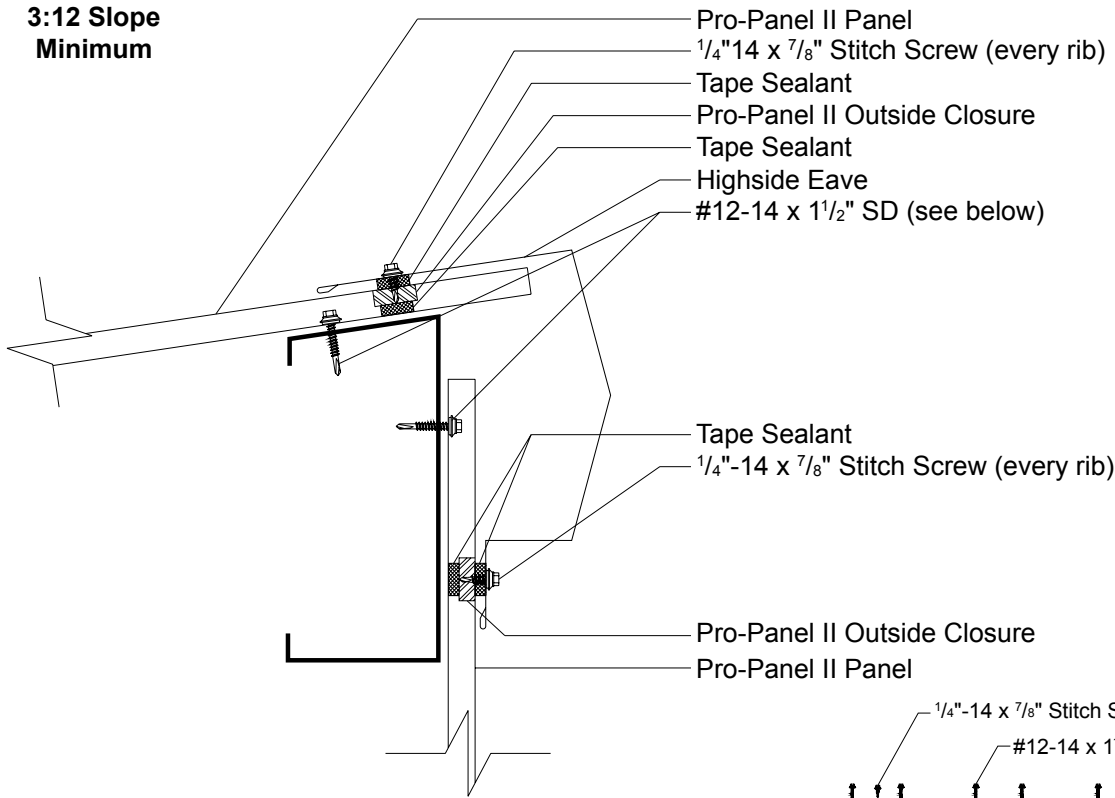

Pro-Panel II Fastening Pattern

PRO-PANEL II 20" RIDGE/HIP DETAIL

3:12 Slope
Minimum

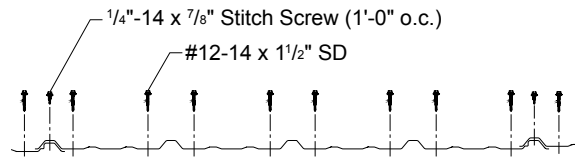
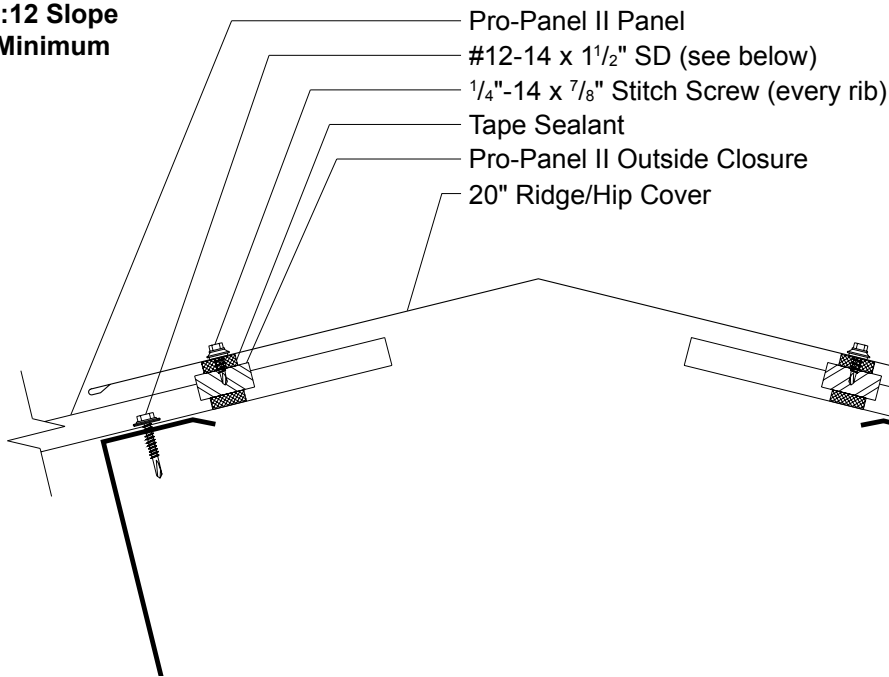

Pro-Panel II Fastening Pattern

PRO-PANEL II® RIDGE DETAIL

3:12 Slope
Minimum

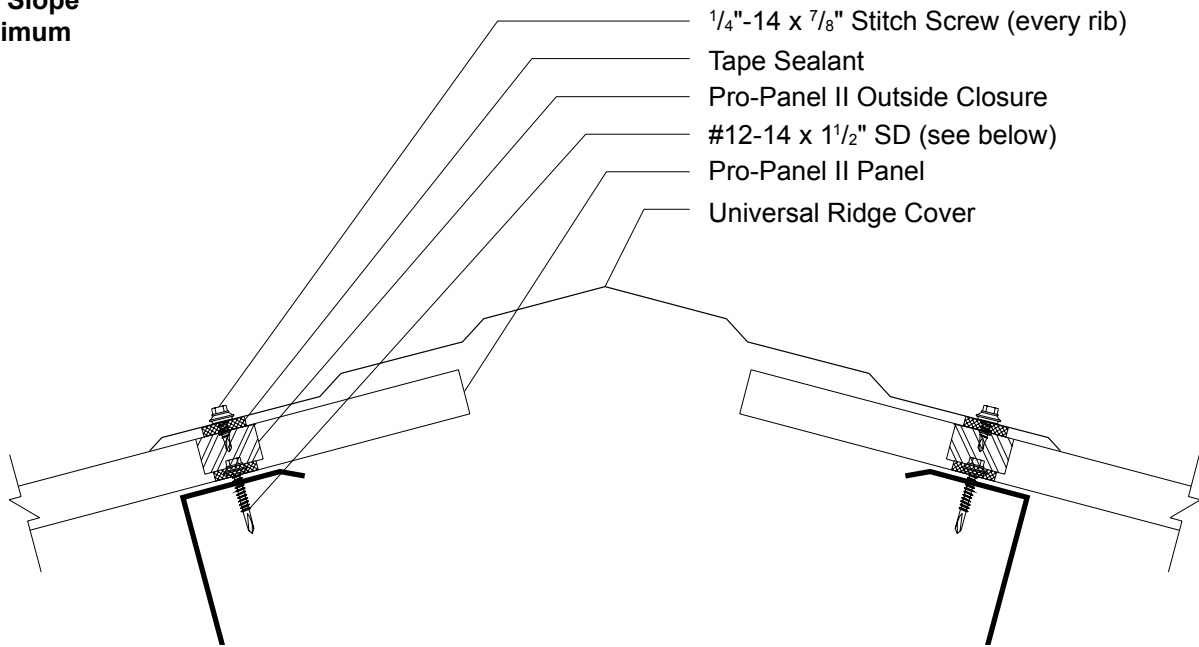

- 1/4"-14 x 7/8" Stitch Screw (every rib)
- Tape Sealant
- Pro-Panel II Outside Closure
- #12-14 x 1 1/2" SD (see below)
- Pro-Panel II Panel
- Universal Ridge Cover

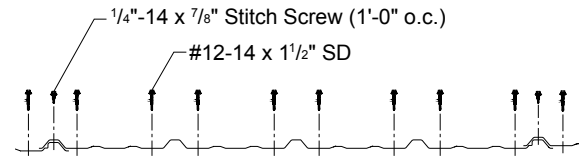

Pro-Panel II Fastening Pattern

PRO-PANEL II GRAVEL STOP DETAIL

3:12 Slope
Minimum

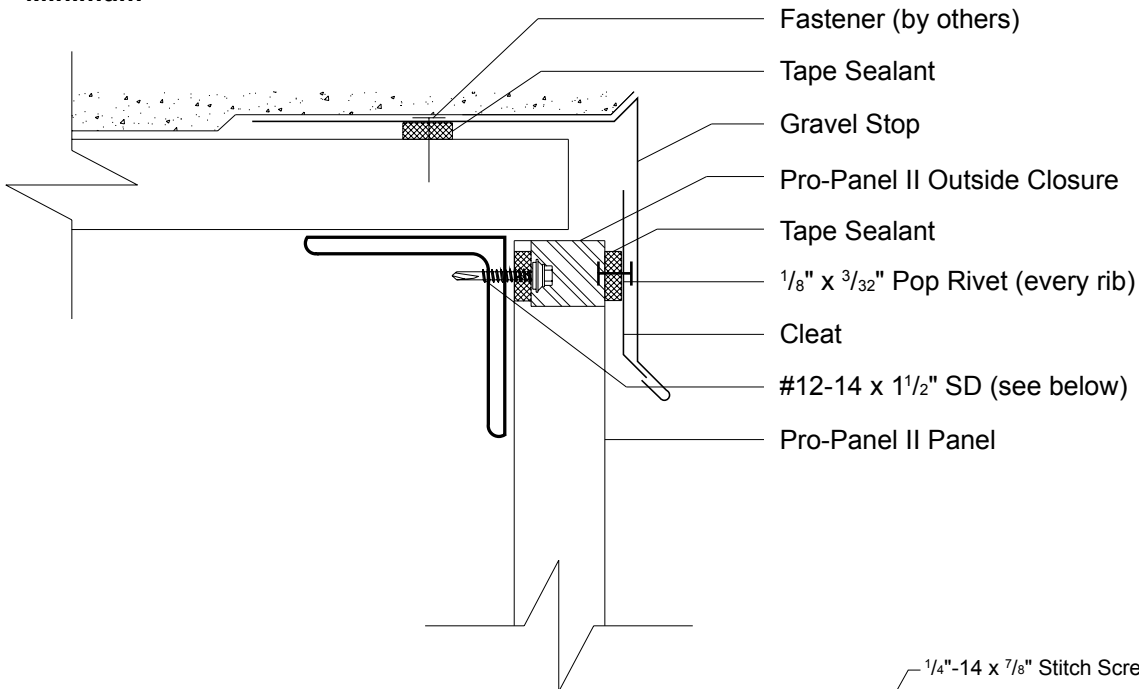

- Fastener (by others)
- Tape Sealant
- Gravel Stop
- Pro-Panel II Outside Closure
- Tape Sealant
- 1/8" x 3/32" Pop Rivet (every rib)
- Cleat
- #12-14 x 1 1/2" SD (see below)
- Pro-Panel II Panel

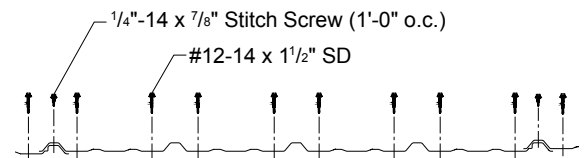

Pro-Panel II Fastening Pattern

PRO-PANEL II® OUTSIDE CORNER DETAIL

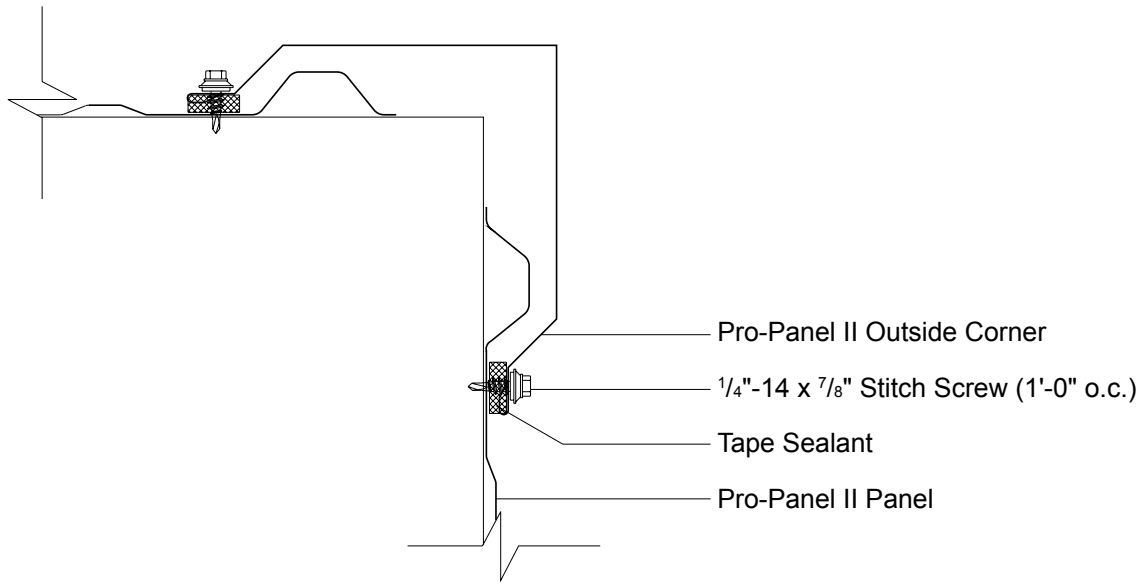

PRO-PANEL II INSIDE CORNER DETAIL

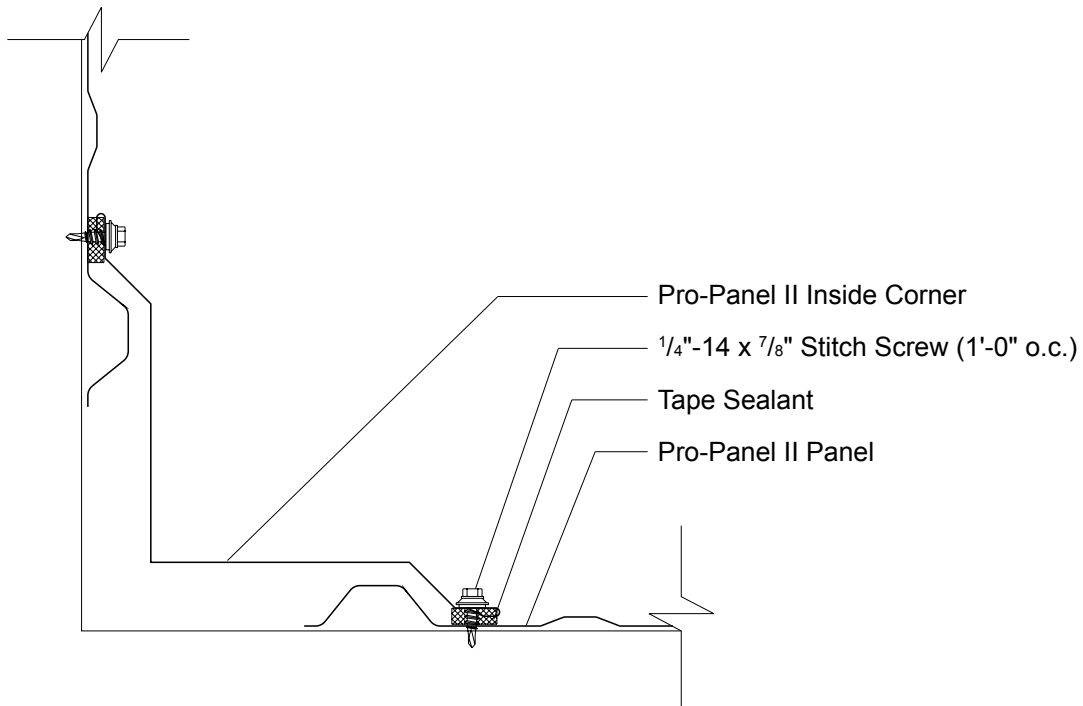

PRO-PANEL II® JAMB DETAIL

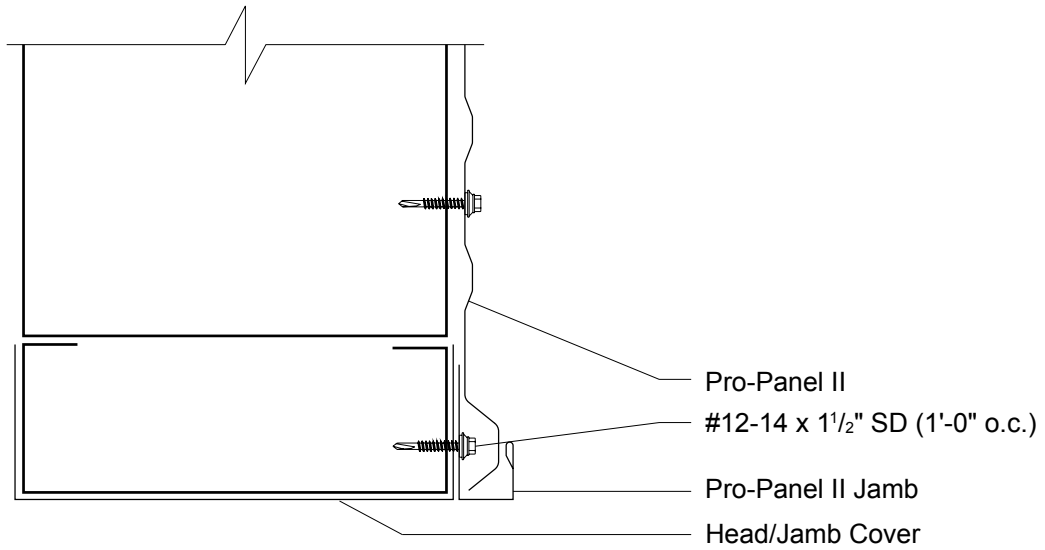

PRO-PANEL II HEAD DETAIL

