

Product Page No.

Panel Information

R-Panel Profiles..... PRP-2
 Panel Overview PRP-2

Flashing Profiles

Eave (Direct Fasten)..... PRP-3
 Sculptured Gutter PRP-3
 Sculptured Gutter End PRP-3
 Universal Gutter/Downspout Strap PRP-3
 Downspout..... PRP-3
 95° Elbow PRP-3
 Downspout Bracket PRP-3
 Gutter Hanger..... PRP-3
 Sculptured Corner Box PRP-3
 Sculptured Peak Box..... PRP-3
 Valley PRP-3
 R-Panel Sculptured Rake..... PRP-3
 Sculptured Rake End..... PRP-3
 Pitch Break PRP-3
 Sculptured High Side Eave..... PRP-3
 Counter Flashing PRP-4
 Reglet Flashing..... PRP-4
 20" Ridge/Hip PRP-4
 Universal Ridge Cover..... PRP-4
 R-Panel Formed Ridge..... PRP-4
 Vented Ridge Cover PRP-4
 Vent Drip..... PRP-4
 Gravel Stop..... PRP-4
 R-Panel Inside Corner PRP-4
 R-Panel Outside Corner PRP-4
 Inside Corner PRP-4
 Outside Corner PRP-4
 1.5" Sill/Head..... PRP-4
 1.5" Sill to Soffit PRP-4
 1.25" Base PRP-4
 R-Panel Jamb..... PRP-5
 Head Channel..... PRP-5
 Head/Jamb Cover..... PRP-5
 R-Panel C-Closure PRP-5

Accessory Profiles

R-Panel Closures PRP-6
 Universal Closure PRP-6
 R-Panel Light Transmitting Panel..... PRP-6
 Vent Material..... PRP-6
 Tube Sealant PRP-6
 Tape Sealant..... PRP-6
 Rubber Roof Jack..... PRP-6
 Retro Roof Jack..... PRP-6
 Rubber Roof Flashing Kit PRP-6
 Touch-Up Paint..... PRP-6
 Continuous Ridge Vent..... PRP-6
 Louver with Screen..... PRP-6
 R-Panel Shear PRP-6

Testing Information

UL 580 Wind Uplift Information..... PRP-7
 Section Properties and General Information PRP-8-9

Design/Installation Considerations

Fastener Installation Technique..... PRP-10
 Condition of Substructure..... PRP-10
 Fastening Information..... PRP-11

Product Page No.

Detail Conditions

Eave Detail PRP-12
 Sculptured Gutter Detail PRP-12
 Valley Detail PRP-13
 Sculptured Rake Detail..... PRP-13
 Rakewall Detail..... PRP-14
 Sculptured High Side Eave Detail PRP-14
 Endwall Detail..... PRP-15
 Ridge/Hip Detail..... PRP-15
 Universal Ridge Detail PRP-16
 Formed Ridge Detail..... PRP-16
 Gravel Stop Detail PRP-17
 R-Panel Outside Corner Detail..... PRP-17
 R-Panel Inside Corner Detail..... PRP-18
 Jamb Detail..... PRP-18
 Head Detail..... PRP-19
 Base Detail PRP-19

Notes

Notes PRP-20

R-PANEL PROFILE

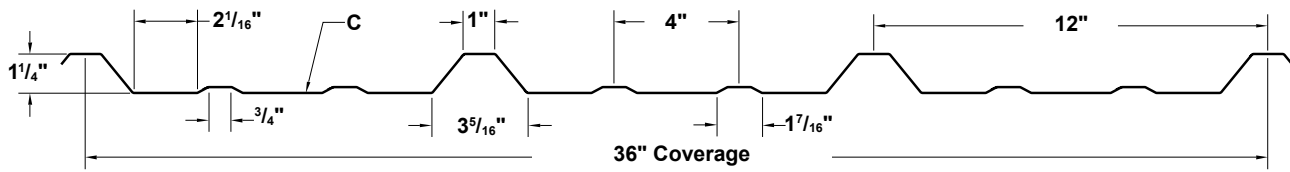

PBR-PANEL PROFILE

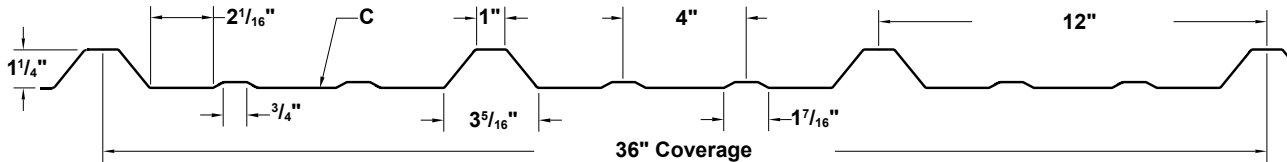

SLOPE

The minimum recommended slope for any "R" and "PBR"-Panel is 1:12. Metal Sales recommends that in all roof applications sealant be used on sidelaps.

SUBSTRATE

R-Panel is designed to be utilized over open structural framing, but can easily be used with a solid substrate. The recommended substrate is 5/8" plywood with a 30 pound felt moisture barrier. To avoid panel distortion, use a properly aligned and uniform substructure. **PBR-Panel is recommended for roof applications.**

COVERAGE

Each panel has a coverage of 36".

LENGTH

Lengths under 5'-0" are available with some cutting restrictions. Maximum recommended panel length is 45'-0". Longer panels require additional consideration in packaging, shipping, and erection. Please consult your Metal Sales branch for recommendations (see PGI-2 and PGI-3 for locations).

AVAILABILITY

Panels are available in 26, 24, and 22 gauge. Minimum quantities may apply.

APPLICATION

Commercial, Industrial, and Architectural panels.

PERFORMANCE TEST

UL 580, UL 2218, UL 790, Texas Department of Insurance, Cantilever Diaphragm.

FASTENING SYSTEM

Direct Fastened (exposed).

FASTENERS

The fastener selection guide should be consulted for choosing proper fasteners for specific applications. Quantity and type of fastener must meet necessary loading and code requirements (see PGI-12-14).

MATERIALS

Steel grade 50 per ASTM A-792
Steel grade 80 per ASTM A-792 or ASTM A-653

FINISH

- ▶ *Acrylic Coated Galvalume® (ACG) / ASTM A-792 - AZ55
 - ▶ Prepainted Galvalume / ASTM A-792 - AZ50
 - ▶ MS Colorfast45®
 - ▶ **Fluorocarbon (PVDF)
- * Differential appearance of Acrylic Coated Galvalume roofing materials is not a cause for rejection.
** Meets both Kynar 500 and Hylar 5000 specifications.

EAVE (DIRECT FASTEN)

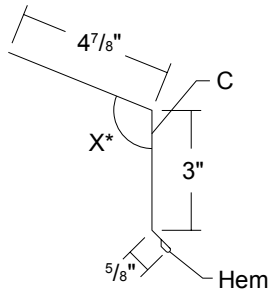

Length 10'-2" - *Specify Slope Angle

SCULPTURED GUTTER

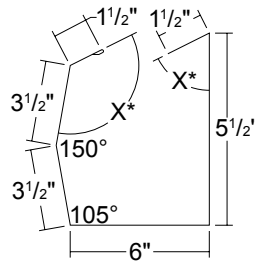

Length 10'-2", 20'-3" - *Specify Slope Angle

SCULPTURED GUTTER END

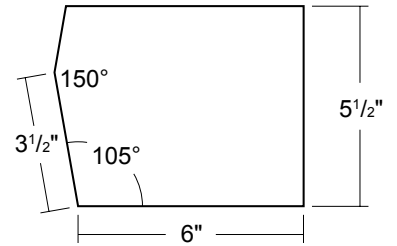

UNIVERSAL GUTTER/ DOWNSPOUT STRAP

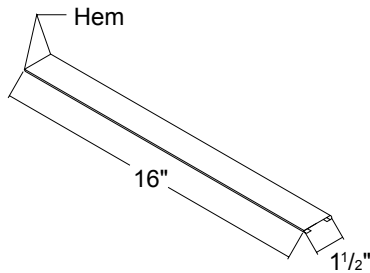

DOWNSPOUT 6" x 4"

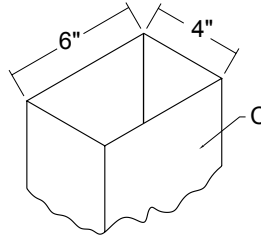

Length 10'-2", 20'-3"
(Also available 4" x 3 1/2")

95° ELBOW 6" x 4"

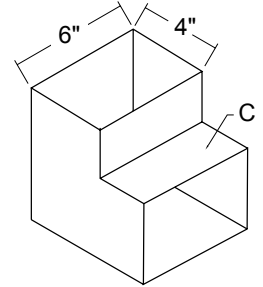

(Also available 4" x 3 1/2")

DOWNSPOUT BRACKET

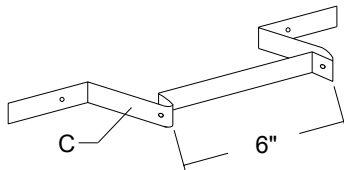

(Also available 4")

GUTTER HANGER

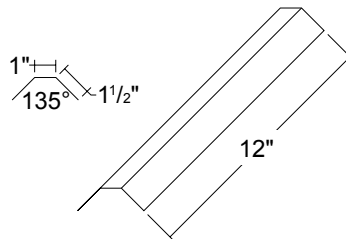

SCULPTURED CORNER BOX

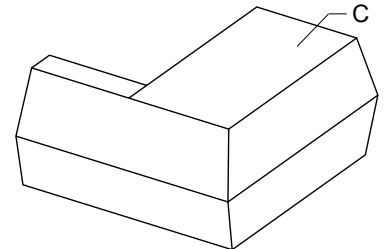

SCULPTURED PEAK BOX

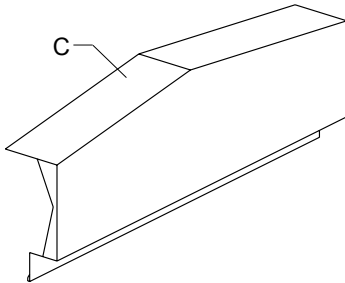

VALLEY

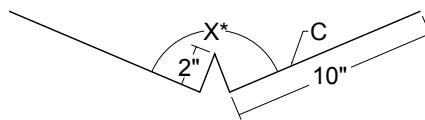

Length 10'-2", 20'-3" - *Specify Slope Angle

R-PANEL SCULPTURED RAKE

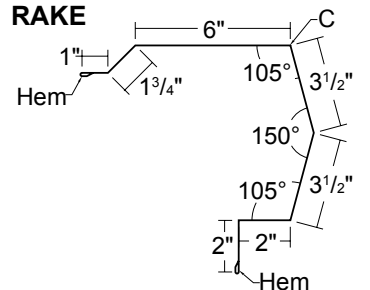

Length 10'-2", 20'-3"

SCULPTURED RAKE END

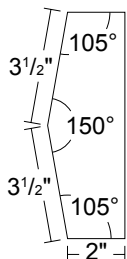

PITCH BREAK

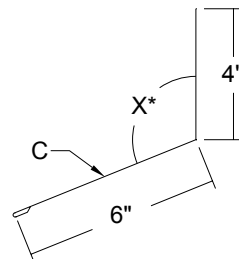

Length 10'-2" - *Specify Slope Angle

SCULPTURED HIGH SIDE EAVE

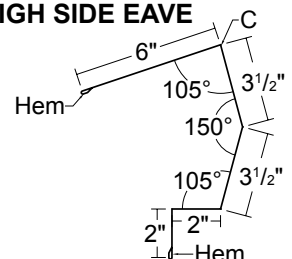

Length 10'-2", 20'-3"

R-PANEL FLASHING PROFILES (CONT.)

COUNTER FLASHING

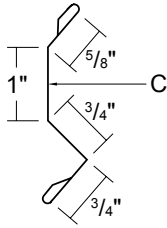

Length 10'-2"

REGLET FLASHING

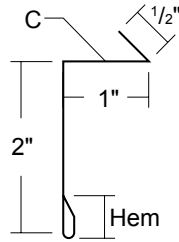

Length 10'-2"

20" RIDGE/HIP COVER

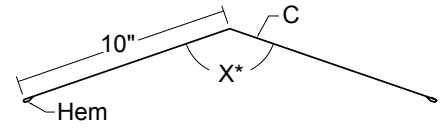

Length 10'-2", 20'-3" - *Specify Slope Angle

UNIVERSAL RIDGE COVER

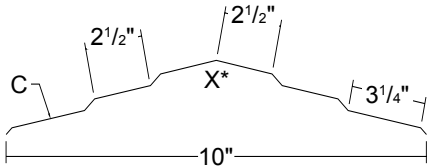

Length 10'-2" - *Specify Slope Angle

R-PANEL FORMED RIDGE

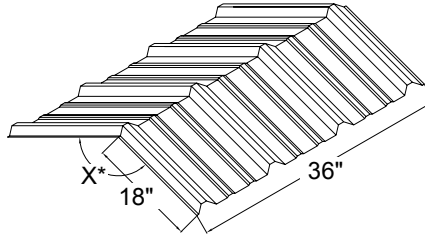

*Specify Slope Angle

VENTED RIDGE COVER

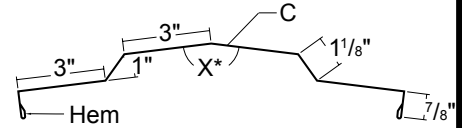

Length 10'-2", 20'-3" - *Specify Slope Angle

VENT DRIP

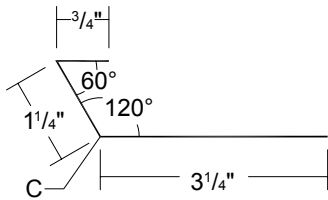

Length 10'-2"

GRAVEL STOP

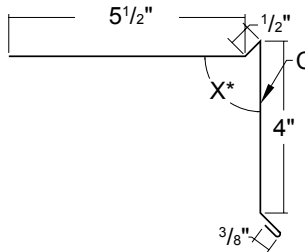

Length 10'-2", 20'-3" - *Specify Slope Angle

R-PANEL INSIDE CORNER

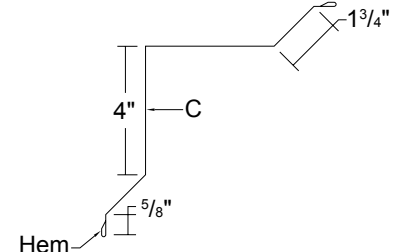

Length 10'-2", 14'-2", 20'-3"

R-PANEL OUTSIDE CORNER

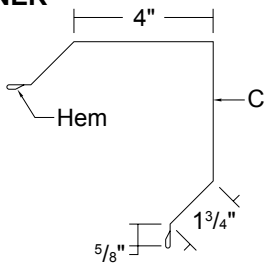

Length 10'-2", 14'-2", 20'-3"

INSIDE CORNER

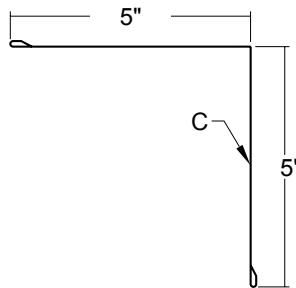

Length 10'-2", 20'-3"

OUTSIDE CORNER

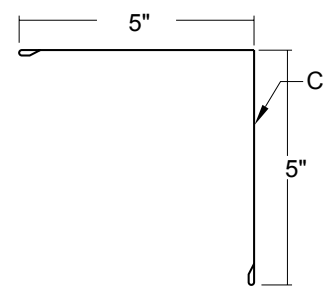

Length 10'-2", 20'-3"

1.5" SILL/HEAD

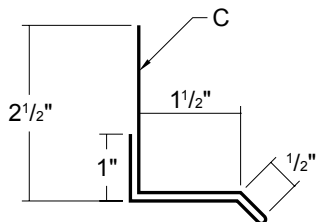

Length 10'-2"

1.5" SILL TO SOFFIT

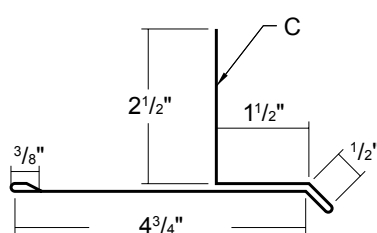

Length 10'-2"

1.25" BASE

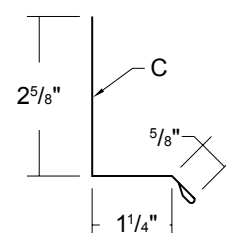

Length 10'-2"

R-PANEL FLASHING PROFILES (CONT.)

R-PANEL JAMB

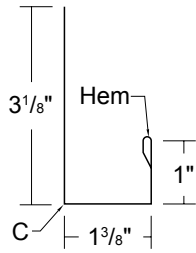

Length 7'-3", 10'-2", 14'-2"

HEAD CHANNEL

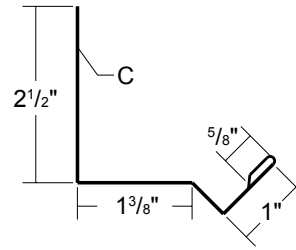

Length 10'-2"

HEAD/JAMB COVER

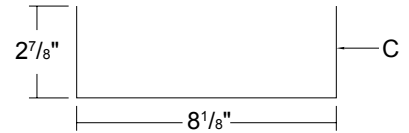

Length 10'-2", 14'-2"

R-PANEL C-CLOSURE

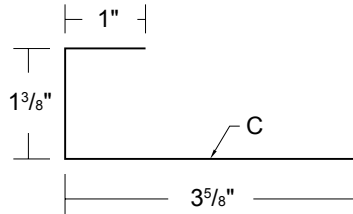

Length 10'-2"

C- Indicates color side of flashing.

R-PANEL CLOSURES



Outside Closure

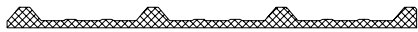

Inside Closure

Synthetic Rubber

UNIVERSAL CLOSURE

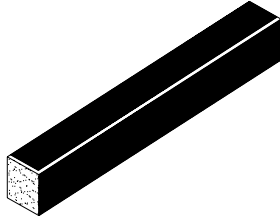

1" x 1 1/2" x 50' Polyethylene Foam
1" x 1 1/2" x 10' Polyethylene Foam

R-PANEL LIGHT TRANSMITTING PANEL

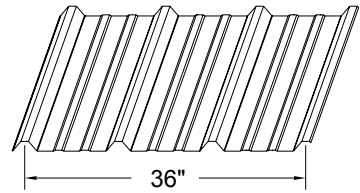

8 Ounce White Fiberglass

VENT MATERIAL

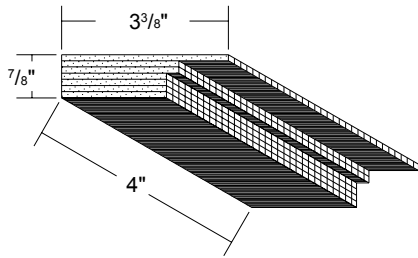

TUBE SEALANT

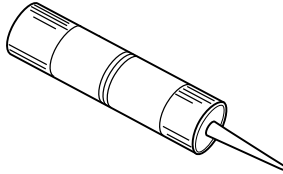

10.3 oz. Cartridge Urethane

TAPE SEALANT



3/8" X 3 3/32" X 50'
Single Bead Butyl - Gray

RUBBER ROOF JACK

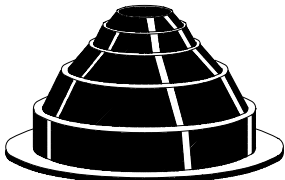

MINI (1/4" to 1 1/8" O.D. Pipe)
#2 (1 3/4" to 3" O.D. Pipe)
#4 (3" to 6" O.D. Pipe)
#6 (6" to 9" O.D. Pipe)
#8 (7" to 13" O.D. Pipe)

RETRO ROOF JACK

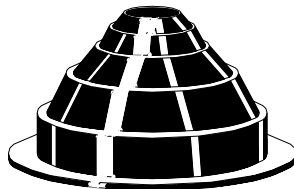

#801_{RETRO} (3/4" to 2 3/4" O.D. Pipe)
#802_{RETRO} (2" to 7 1/4" O.D. Pipe)
#803_{RETRO} (3 1/4" to 10" O.D. Pipe)

RUBBER ROOF FLASH KIT

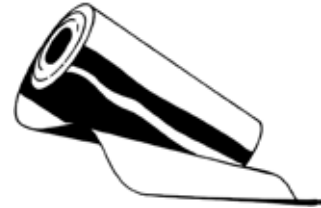

12" x 50'-0" Flash Kit
18" x 50'-0" Flash Kit

TOUCH-UP PAINT

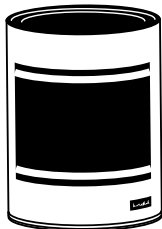

Available in pints
PVDF / MS Colorfast45

CONTINUOUS RIDGE VENT

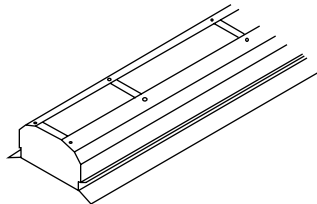

9" x 10', 12" x 10'

LOUVER WITH SCREEN

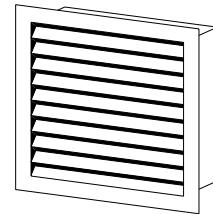

3' x 3', 3' x 4'

R-PANEL SHEAR

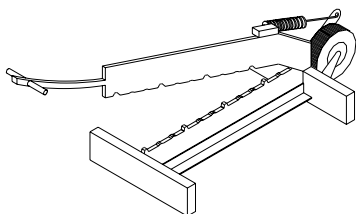

R-PANEL

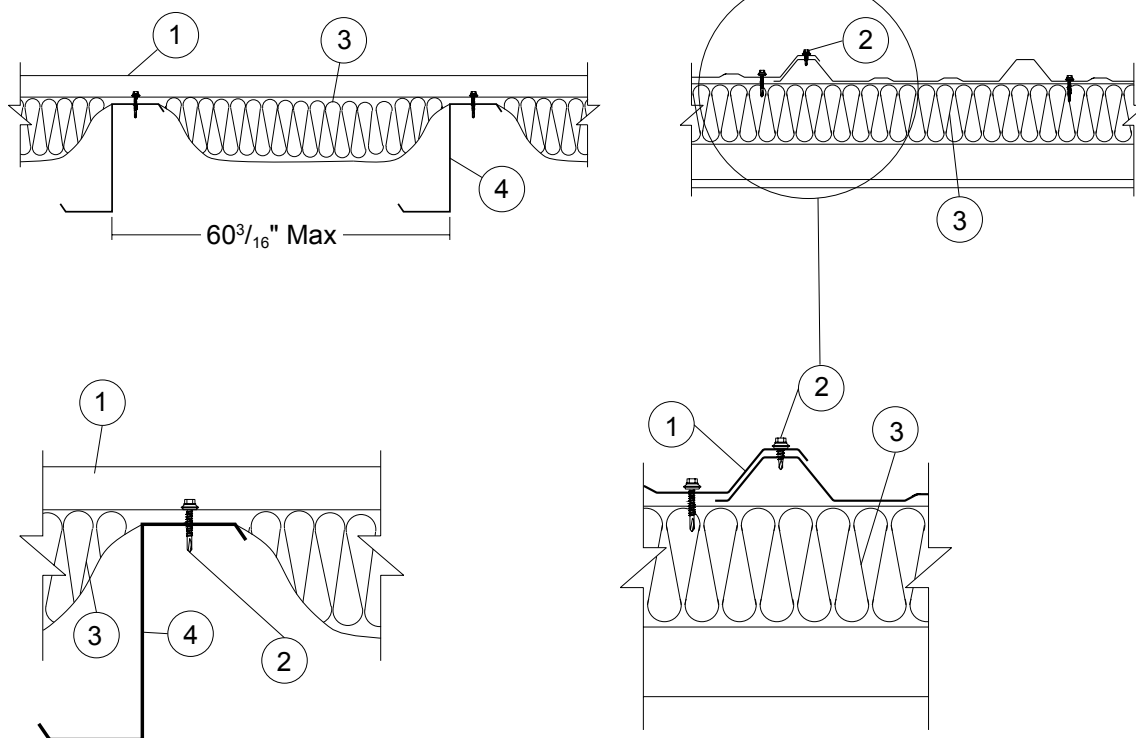

R-PANEL

Construction No. 161

November 02, 2001

Uplift - Class 90

Fire Not Investigated

1. Metal Roof Deck Panels* No. 26 MSG min gauge coated steel. Panels continuous over two or more spans. End laps to occur over purlins with panels overlapped a min of 4 in. with lap centered over purlin web. A line of tape sealant may be used at panel side and end laps.
Metal Sales Manufacturing Corporation "R-Panel" "PBR-Panel".

2. Panel Fasteners For panel to panel and panel to purlin connections to be No. 12-14 by 1 in. self-drilling, self-tapping, hex head, plated steel screws with a 5/8 in. OD formed steel washer and a neoprene sealing washer.

As alternate Fasteners - For panel to purlin connections, 1/4 - 14 HHAB self-tapping, plating steel screws, with a separate 5/8 in. OD dome shaped steel washer and a neoprene sealing washer may be used.

Or: No. 14-10HHA, self-tapping, plating steel screws, with a separate, 5/8 in. OD dome shaped steel washer and a neoprene sealing washer may be used.

Spacing, for panel - to - purlin connections to be 12 in. on center beginning 2 - 1/2 in. from center line on one side of each major rib. Spacing at end lap to be in a 5 - 7 - 5 - 7 in. pattern beginning 2 - 1/2 in. from the center line on both sides of each major rib.

Fastener for panel to purlin connection to be 1-1/4 in. long when insulation (Item 3) is greater than 4-1/2 in.

Spacing for panel - to - panel connections to be 20 in. on center with a fastener located in line with the purlin fasteners.

3. Insulation (Optional) - Any compressible blanket insulation 6 in. max thickness before compression.

4. Purlin No. 16 MSG min gauge steel (50,000 psi min yield).

5. Lateral Bracing (Not shown) - As required.

Refer to General Information, Roof Deck Construction, (Roofing Materials and Systems Directory) for items not evaluated.

* Bearing the UL Classification Mark.



Underwriters Laboratories Inc. ®

LISTED

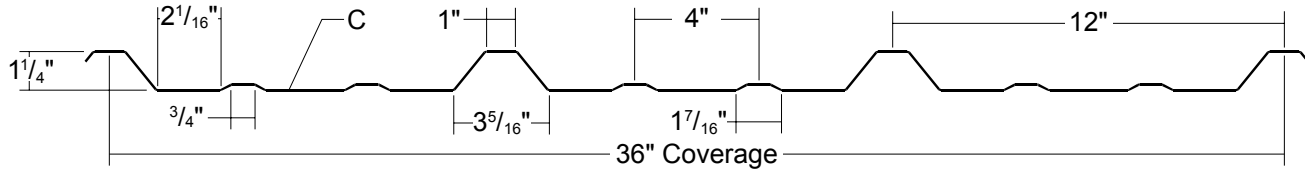

SECTION PROPERTIES								ALLOWABLE UNIFORM LOADS PSF (3 or More Equal Spans)											
Ga.	Width (in.)	Yield KSI	Weight PSF	Top in Compression		Bottom in Compression		Inward Load						Outward Load					
				Ixx In ⁴ /ft	Sxx In ³ /ft	Ixx In ⁴ /ft	Sxx In ³ /ft	2'	3'	4'	5'	6'	7'	2'	3'	4'	5'	6'	7'
26	36"	80	0.87	0.0350	0.0348	0.0293	0.0439	235	119	71	47	27	17	270	132	77	50	35	26
24	36"	50	1.13	0.0543	0.0558	0.0427	0.0595	316	147	85	55	38	27	398	185	106	68	48	35
22	36"	50	1.45	0.0767	0.0814	0.0600	0.0790	434	199	113	73	51	37	594	273	155	100	70	51

- Theoretical section properties have been calculated per AISI 2001 "Specification for the Design of Cold-formed Steel Structural Members." Ixx and Sxx are effective section properties for deflection and bending.
- Allowable load is calculated in accordance with AISI 2001 specifications considering bending, shear, combined bending and shear, deflection, and applicable testing when available. Allowable load considers the worst case of 3 and 4 equal span conditions. Allowable load does not address web crippling or fasteners/support connection and panel weight is not considered.
- Deflection consideration is limited by a maximum deflection ratio of L/180 of span.
- Allowable loads do not include a 1/3 stress increase in uplift.

ATTACHMENT DETAIL

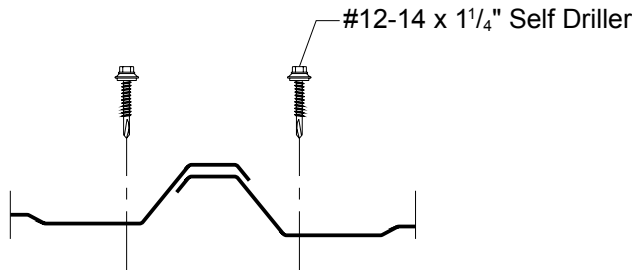

FASTENING PATTERNS

End of Panel

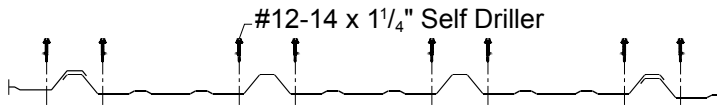

Field of Panel

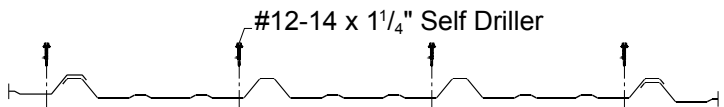

GENERAL INFORMATION

- Substructure**
R-Panel is designed to be utilized over open structural framing but can easily be used with a solid substrate. To avoid panel distortion use a properly aligned and uniform substructure.
- Coverage**
R-Panels are available in a 1 1/4" rib height with a coverage width of 36".
- Length**
Minimum factory cut length is 5'-0". Maximum recommended panel length is 45'-0". Longer panels require additional consideration in packaging, shipping, and erection. Please consult Metal Sales for recommendations.
- Fasteners**
The fastener selection guide should be consulted for choosing the proper fastener for specific applications. Quantity and type of fastener must meet necessary loading and code requirements.
NOTE: All panels are subject to surface distortion due to improperly applied fasteners. Overdriven fasteners will cause stress and induce oil canning across the face of the panel at or near the point of attachment.
- Availability**
Finishes: Acrylic Coated Galvalume®, MS Colorfast45®, or various Kynar 500 (PVDF) colors.
Gauges: 26ga and 24ga standard, 22ga optional

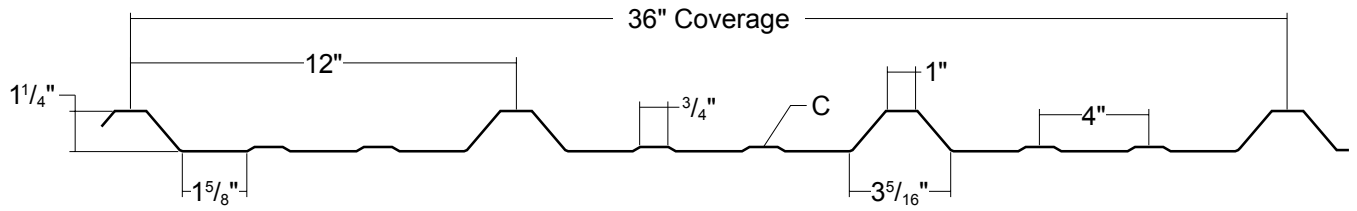

SECTION PROPERTIES								ALLOWABLE UNIFORM LIVE LOADS PSF (3 or More Equal Spans)											
Ga.	Width (in.)	Yield KSI	Weight PSF	Top in Compression		Bottom in Compression		Inward (Gravity / Deflection) Load						Outward Uplift (Stress) Load					
				Ixx In ⁴ /ft	Sxx In ³ /ft	Ixx In ⁴ /ft	Sxx In ³ /ft	2'	3'	4'	5'	6'	7'	2'	3'	4'	5'	6'	7'
26	36"	80	0.91	0.0360	0.0358	0.0313	0.0452	256	127	74	49	34	23	217	104	60	39	27	20
24	36"	50	1.17	0.0560	0.0578	0.0457	0.0613	330	153	88	57	39	29	314	145	83	53	37	27
22	36"	50	1.51	0.0800	0.0856	0.0633	0.0813	451	206	117	75	52	39	472	217	123	79	55	40

- Theoretical section properties have been calculated per AISI 2001 "Specification for the Design of Cold-formed Steel Structural Members." Ixx and Sxx are effective section properties for deflection and bending.
- Allowable load is calculated in accordance with AISI 2001 specifications considering bending, shear, combined bending and shear, deflection, and applicable testing when available. Allowable load considers the worst case of 3 and 4 equal span conditions. Allowable load does not address web crippling or fasteners/support connection and panel weight is not considered.
- Deflection consideration is limited by a maximum deflection ratio of L/180 of span.
- Allowable loads do not include a 1/3 stress increase in uplift.

ATTACHMENT DETAIL

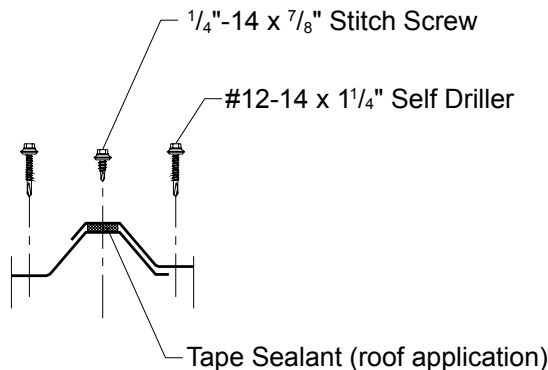

FASTENING PATTERNS

Field of Panel

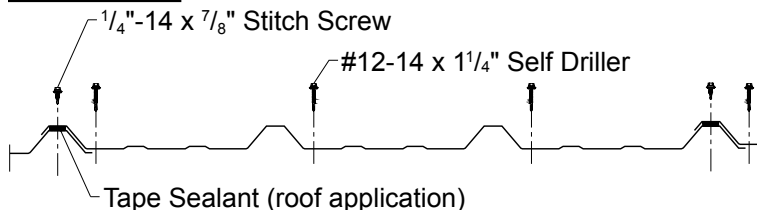

Ends of Panel

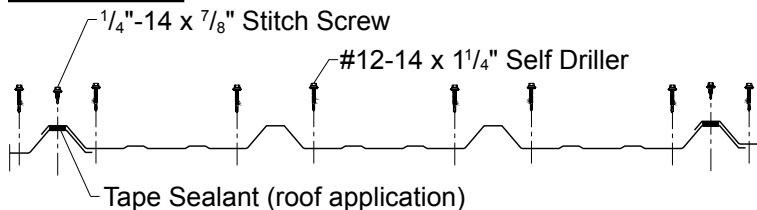

GENERAL INFORMATION

► **Slope**

The minimum recommended slope for PBR-Panel is 1:12. Metal Sales recommends that in all roof applications, sealants be used on all sidelaps with stitch screw 1'-0" on center.

► **Substructure**

PBR-Panel is designed to be utilized over open structural framing, but can easily be used with a solid substrate. To avoid panel distortion, use a properly aligned and uniform substructure.

► **Coverage**

PBR-Panels are available in a 1/4" rib height with a coverage width of 36".

► **Length**

Minimum factory cut length is 5'-0". Maximum recommended panel length is 45'-0". Longer panels require additional consideration in packaging, shipping, and erection. Please consult Metal Sales for recommendations.

► **Fasteners**

The fastener selection guide should be consulted for choosing the proper fastener for specific applications. Quantity and type of fastener must meet necessary loading and code requirements.

NOTE: All panels are subject to surface distortion due to improperly applied fasteners. Overdriven fasteners will cause stress and induce oil canning across the face of the panel at or near the point of attachment.

► **Availability**

Finishes: Acrylic Coated Galvalume®, MS Colorfast45®, or various Kynar 500 (PVDF) colors.
Gauges: 26ga and 24ga standard, 22ga optional

FASTENER INSTALLATION TECHNIQUE

Recommended Tool Type - Use depth locating nose or adjustable clutch on screw gun to prevent overdrilling and strip out. **Do not use impact tools or runners.**

Seating the washer - Apply sufficient torque to seat the washer - do not overdrive the fastener.

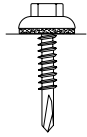
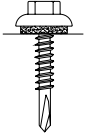
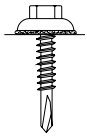
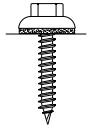
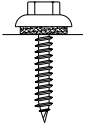
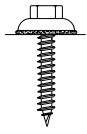
	CORRECT Sealing material slightly visible at edge of metal washer. Assembly is watertight.	TOO LOOSE Sealing material is not visible; not enough compression to seal properly.	TOO TIGHT Metal washer deformed; sealing material pressed beyond washer edge.
SELF DRILLER			
WOODSCREW			

To prevent wobbling - Make sure fastener head is completely engaged in the socket. If the head does not go all the way in the socket - tap the magnet deeper into the socket to allow full head engagement. Metal chips will build up from drilling and should be removed from time to time.

Protect drill point - Push only hard enough on the screw gun to engage clutch. This prevents excess friction and burn out of the drill point. Correct pressure will allow screw to drill and tap without binding.

Drilling through sheet and insulation - Ease up on pressure when drilling through insulation to avoid striking the purlin or girt with the point - apply more pressure after drill point contacts purlin or girt.

Drilling through purlin overlaps - Drilling through lapped purlins requires extra care. Excessive voids between purlins sometimes damages drill points and two self-drillers might be necessary to complete the operation. It is sometimes advantageous to predrill.

CONDITION OF SUBSTRUCTURE

Whether over solid substrate or open structural framing, panel distortion may occur if not applied over properly aligned and uniform substructure.

The installer should check the roof deck for squareness before installing "R"-Panels. Several methods can be used to verify squareness of the structure for proper installation of the panels.

METHOD "A" - One method for checking the roof for squareness is to measure diagonally across one slope of the roof from similar points at the ridge and eave and obtain the same dimension.

METHOD "B" - The 3-4-5 triangle system may also be used. To use this system measure a point from the corner along the edge of the roof at a module of three (3). Measure a point from the same corner along another edge at a module of four (4). Then by measuring diagonally between the two points established, the dimension should be exactly a module of five (5) to have a square corner. Multiple uses of this system may be required to determine building squareness. If the endwall cannot be made square, the roof system cannot be installed as shown in these instructions.

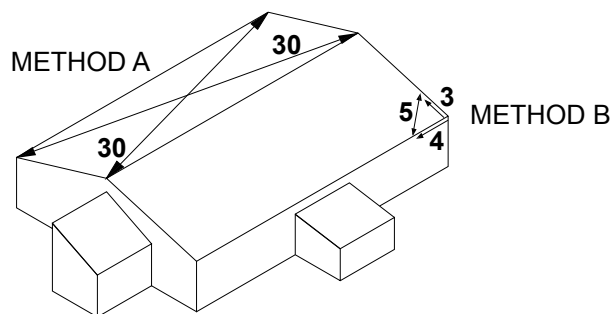

R-PANEL WALL FASTENING PATTERN

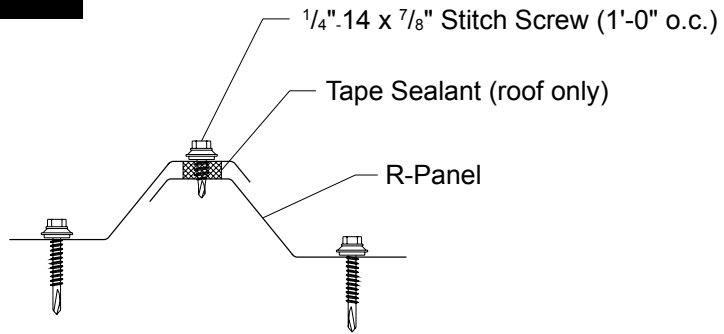

R-Panel Fastening Pattern - Interior



R-Panel Fastening Pattern - Ends

PBR-PANEL ROOF FASTENING PATTERN

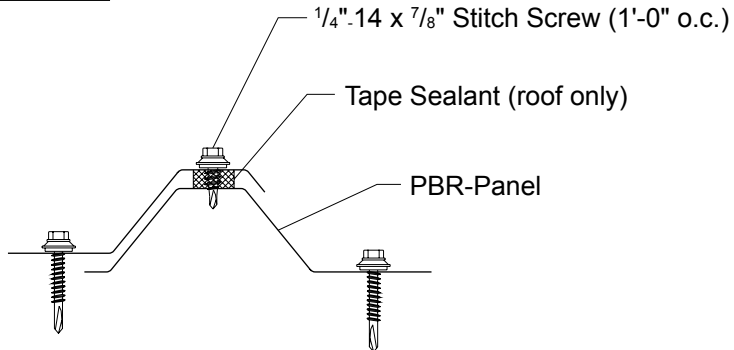

PBR-Panel Fastening Pattern - Interior



PBR-Panel Fastening Pattern - Ends

R-PANEL

EAVE DETAIL

1:12 Slope
Minimum

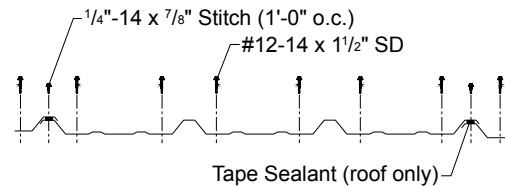
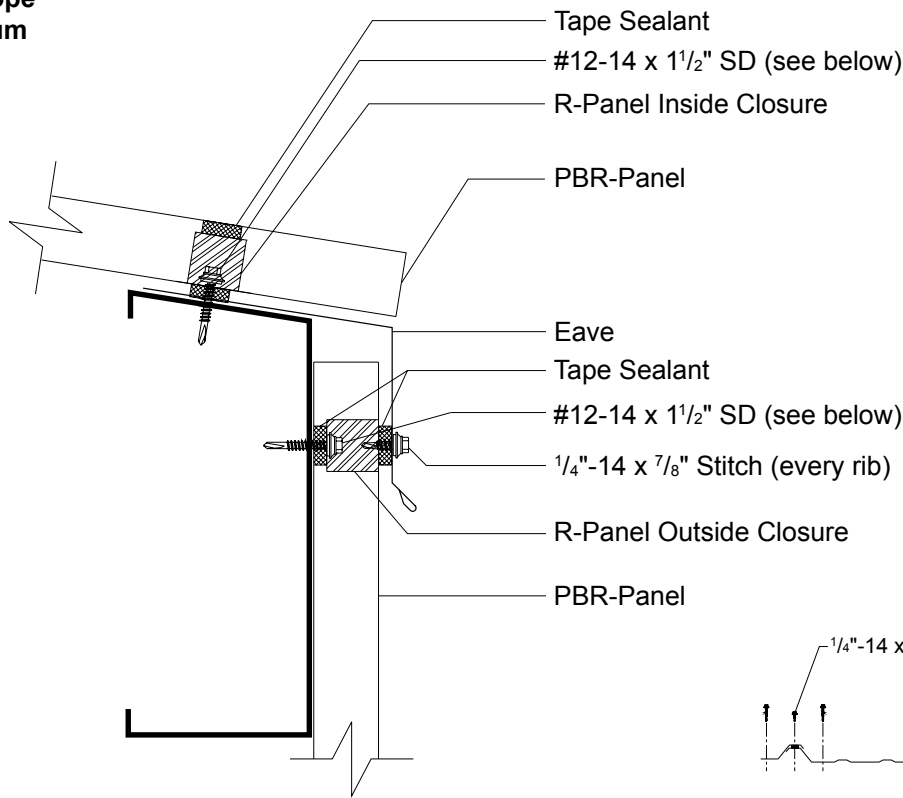

R-Panel Fastening Pattern

R-PANEL

SCULPTURED GUTTER DETAIL

1:12 Slope
Minimum

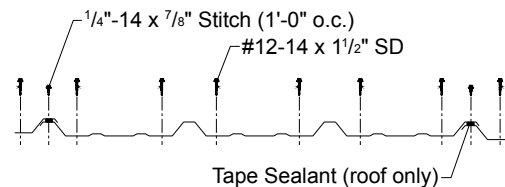
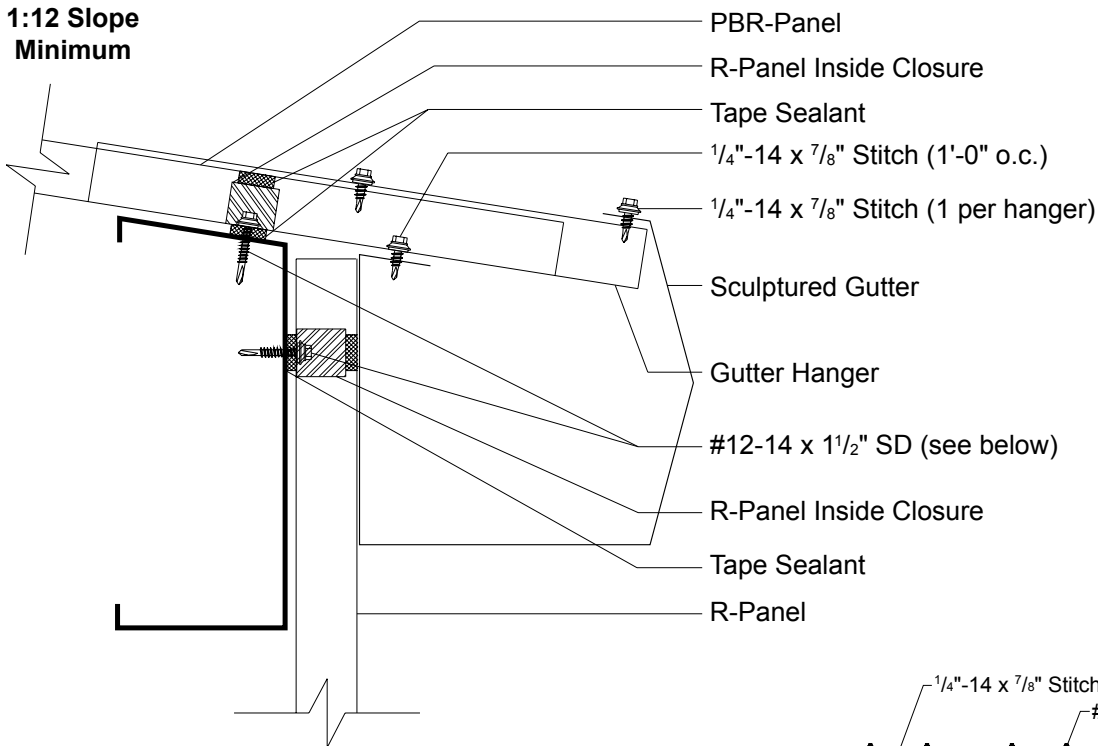

R-Panel Fastening Pattern

R-PANEL

VALLEY DETAIL

1:12 Slope
Minimum

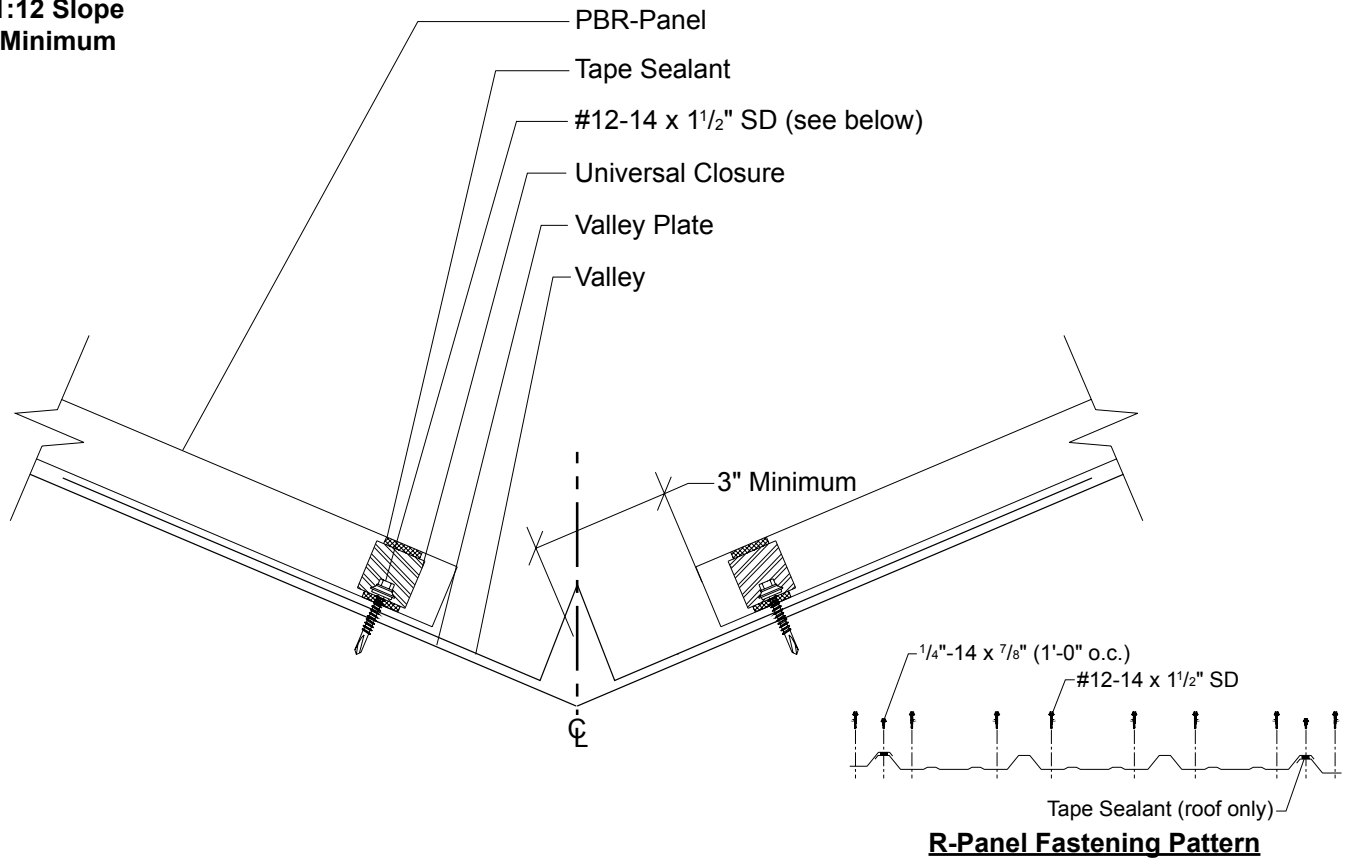

R-PANEL

SCULPTURED RAKE DETAIL

1:12 Slope
Minimum

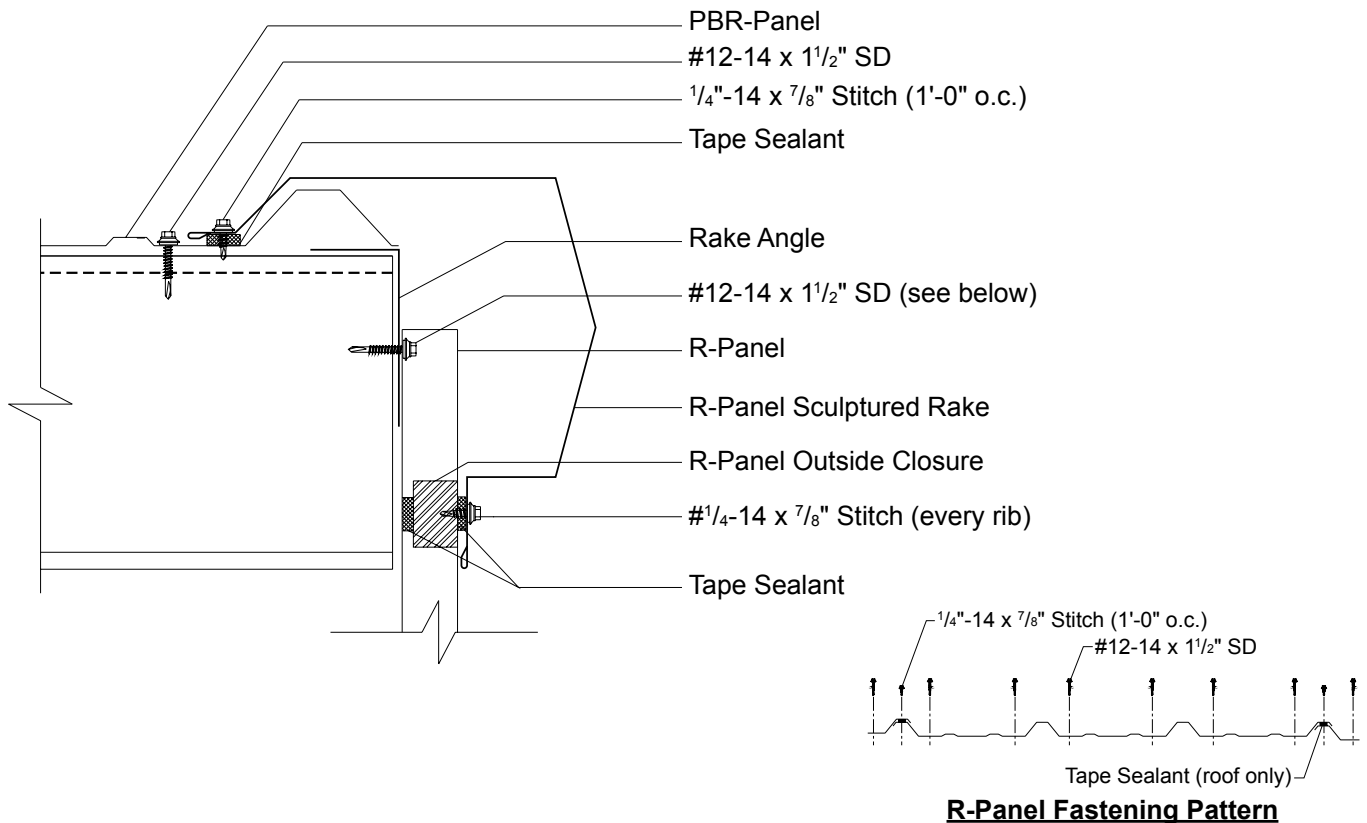

R-PANEL

RAKEWALL DETAIL

1:12 Slope
Minimum

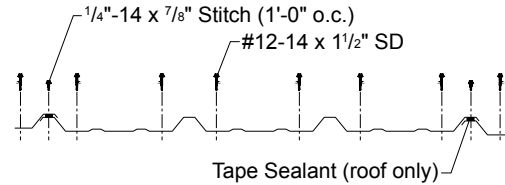
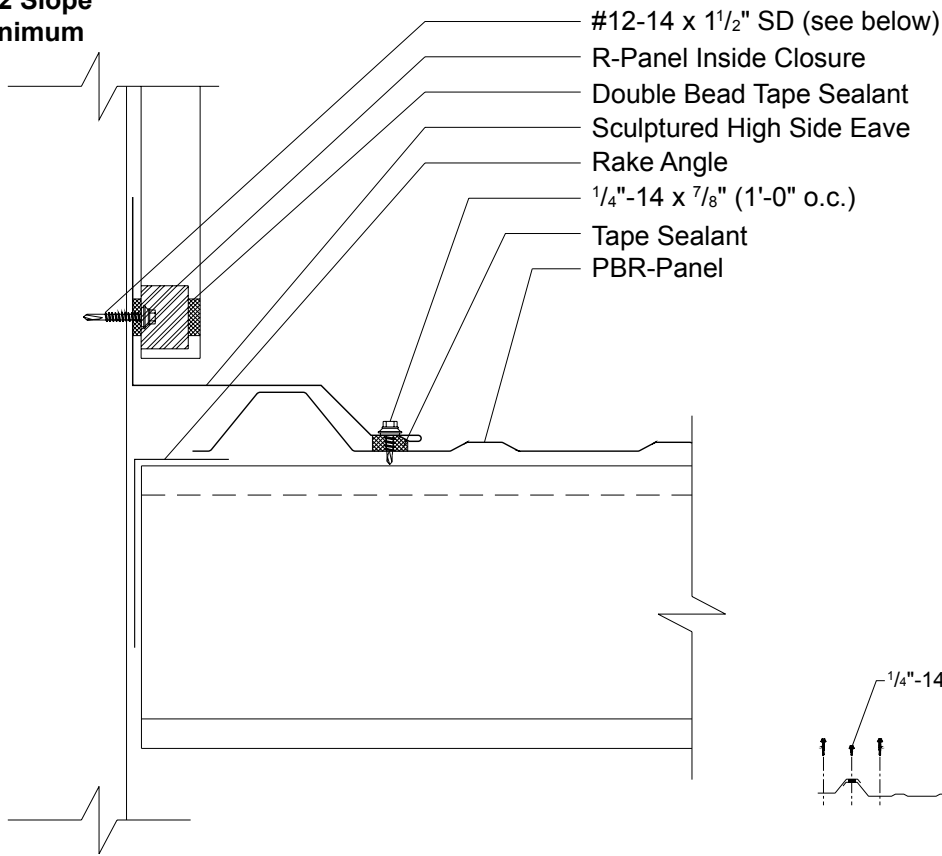

R-Panel Fastening Pattern

R-PANEL

SCULPTURED HIGH SIDE EAVE DETAIL

1:12 Slope
Minimum

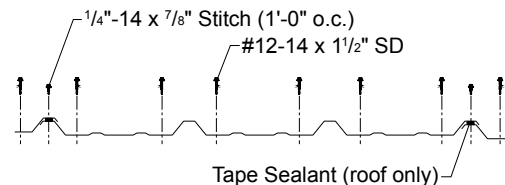
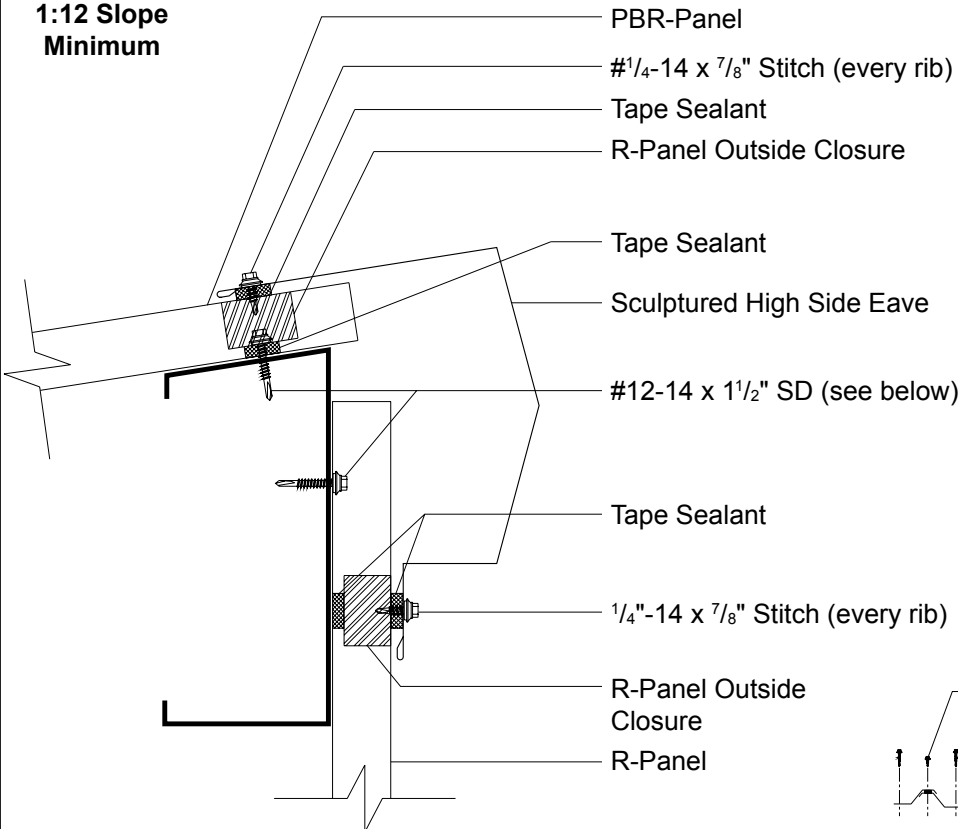

R-Panel Fastening Pattern

R-PANEL

ENDWALL DETAIL

1:12 Slope
Minimum

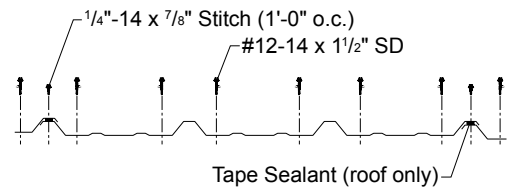
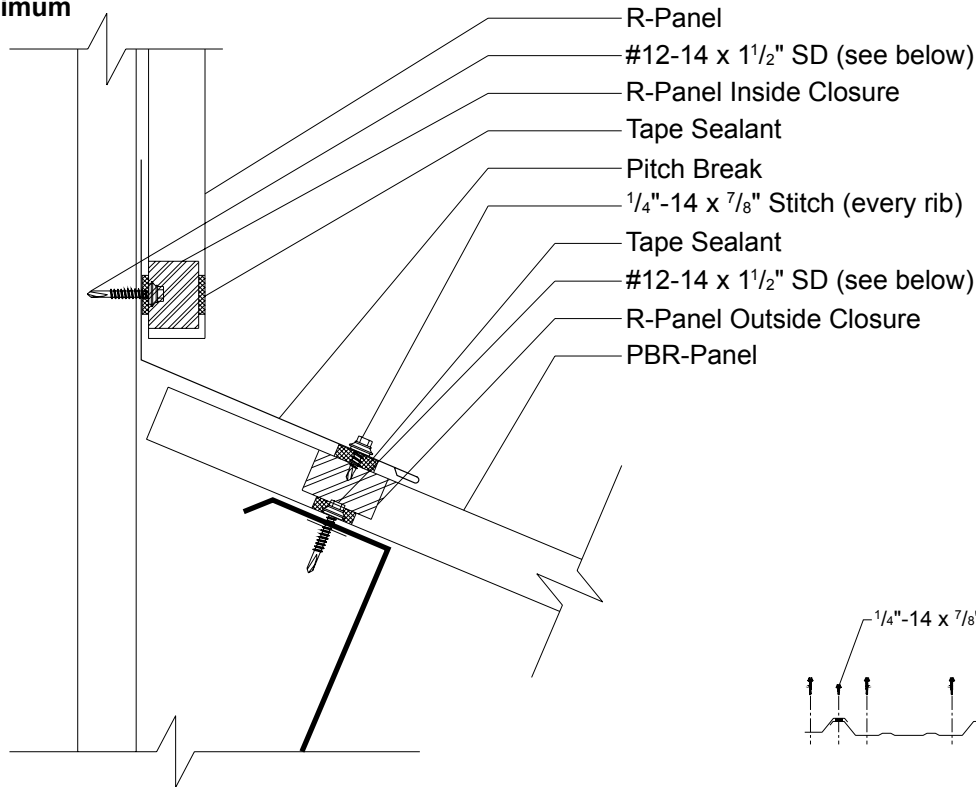

R-Panel Fastening Pattern

R-PANEL

RIDGE/HIP DETAIL

1:12 Slope
Minimum

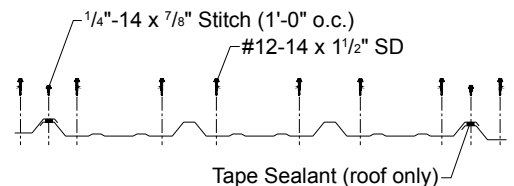
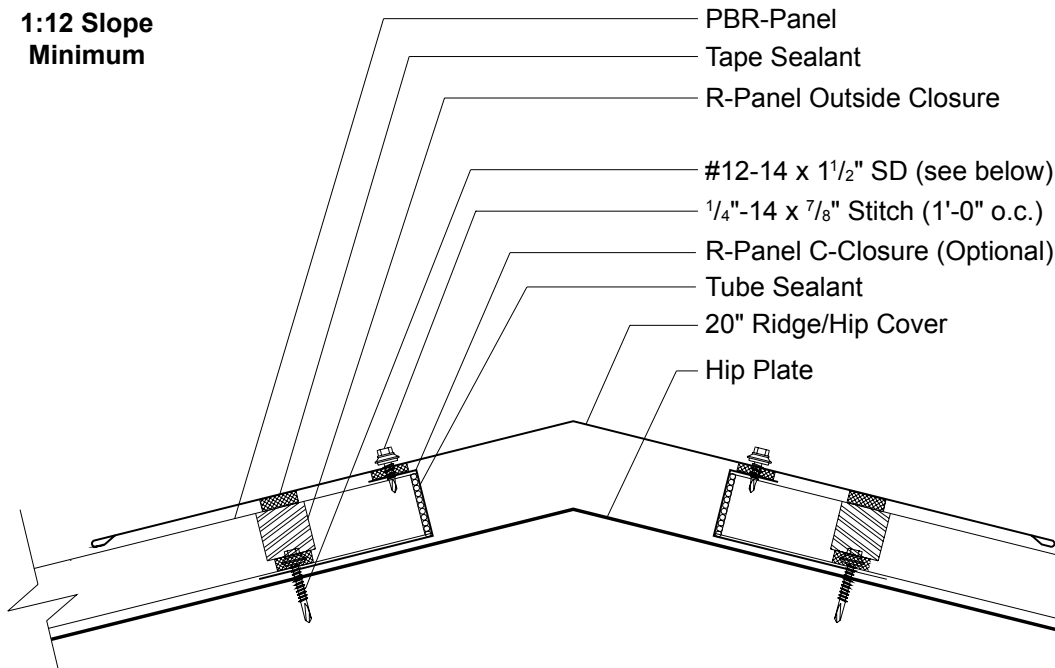

R-Panel Fastening Pattern

R-PANEL

UNIVERSAL RIDGE DETAIL

1:12 Slope
Minimum

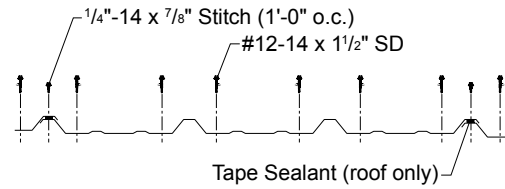
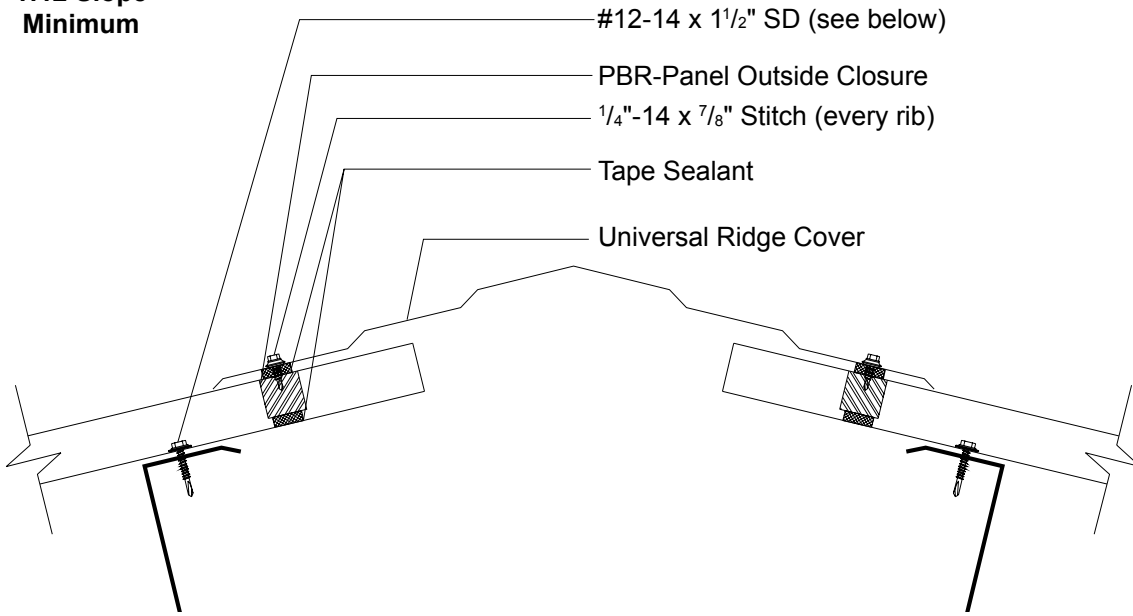

R-Panel Fastening Pattern

R-PANEL

FORMED RIDGE DETAIL

1:12 Slope
Minimum

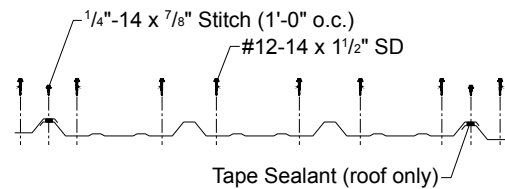
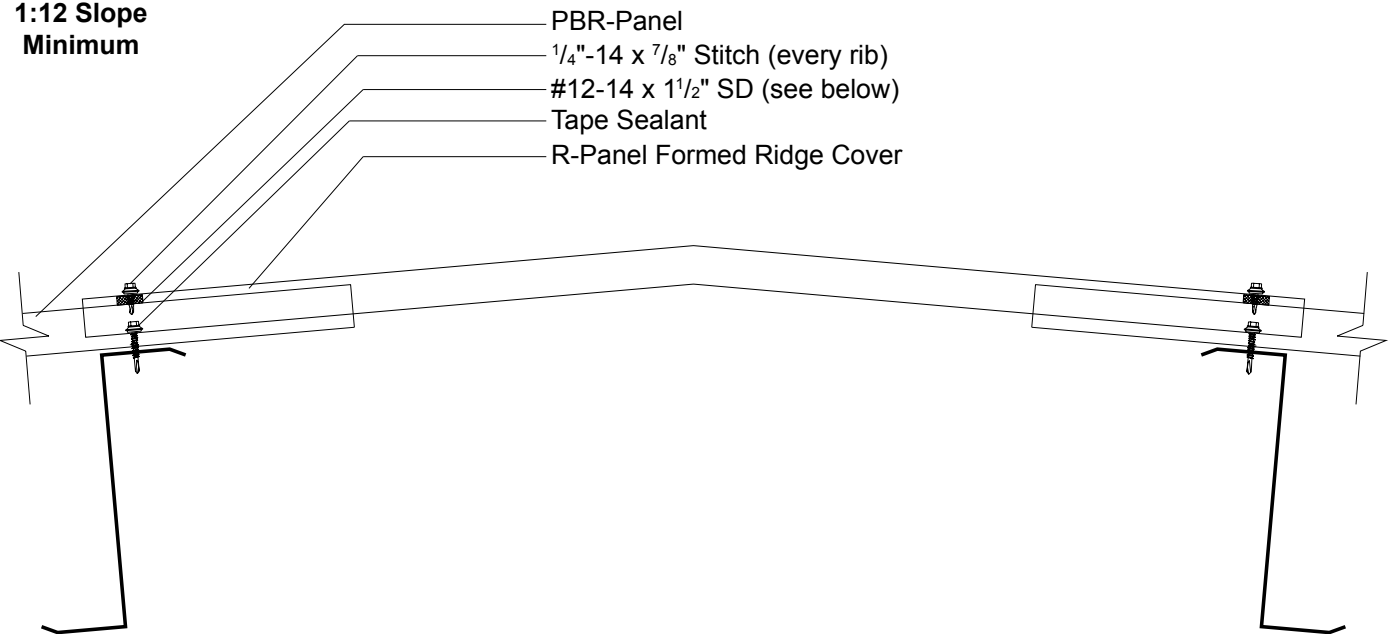

R-Panel Fastening Pattern

R-PANEL

GRAVEL STOP DETAIL

1:12 Slope
Minimum

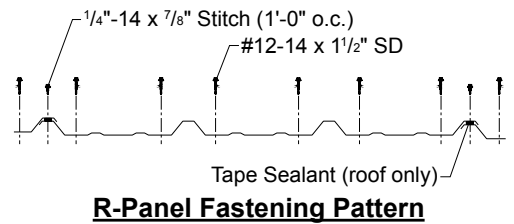
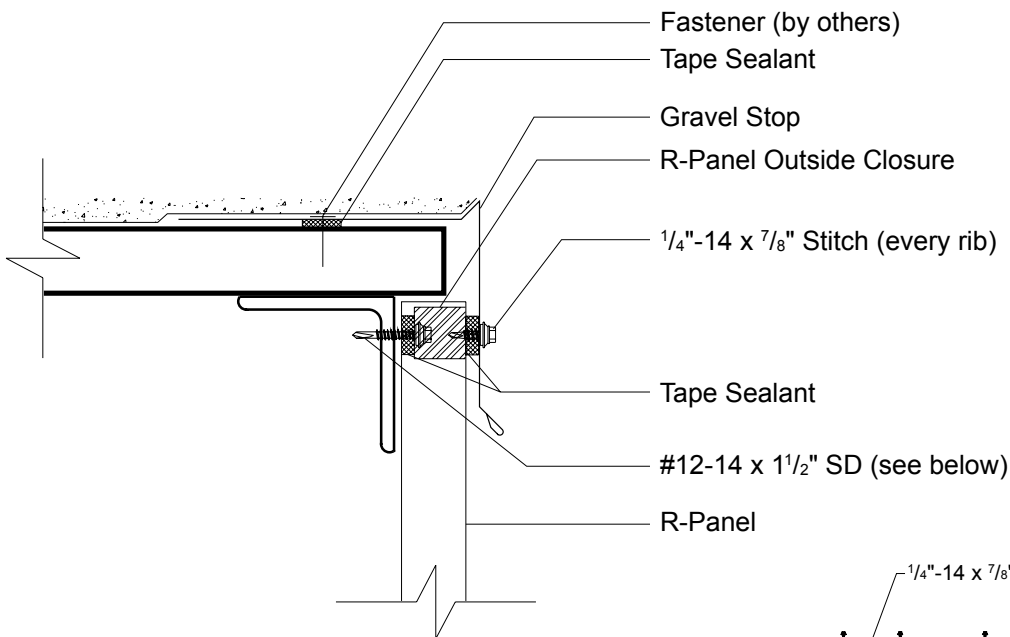

R-PANEL

OUTSIDE CORNER DETAIL

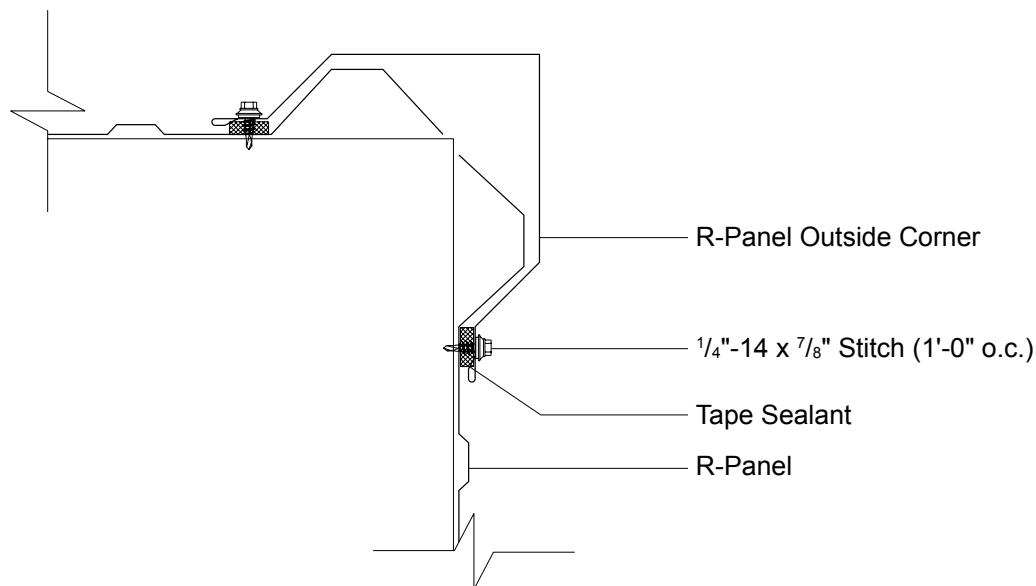

R-PANEL

INSIDE CORNER

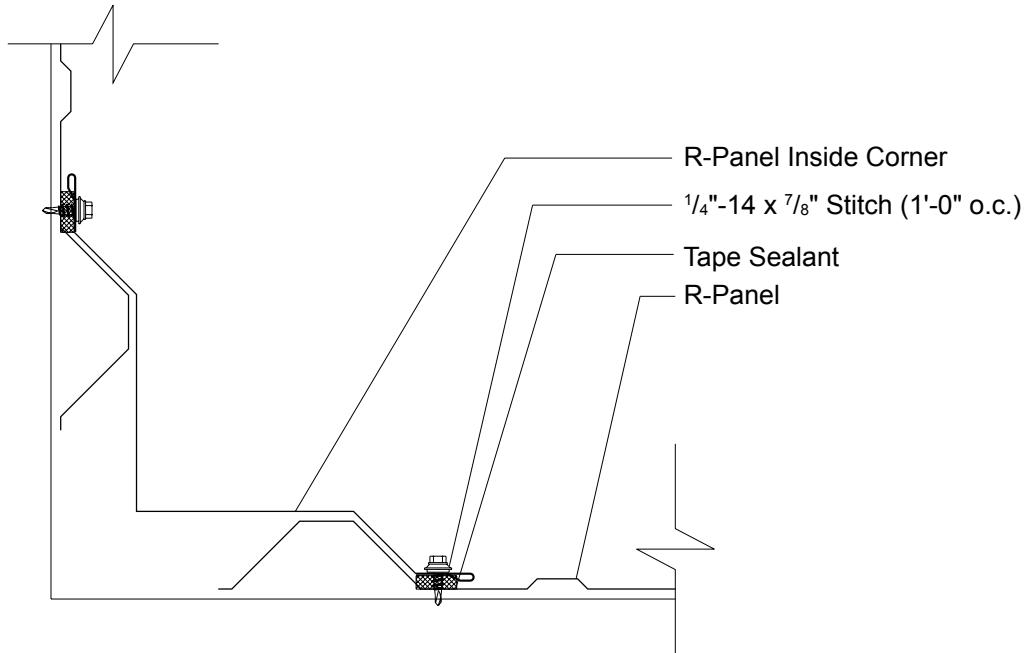

R-PANEL

JAMB DETAIL

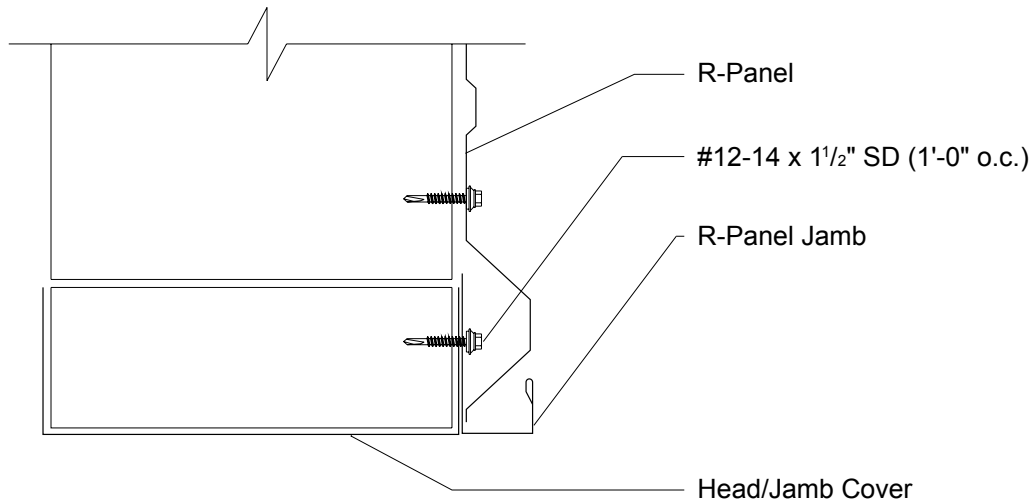

R-PANEL HEAD DETAIL

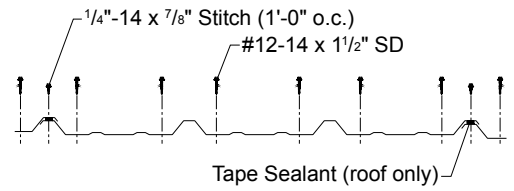
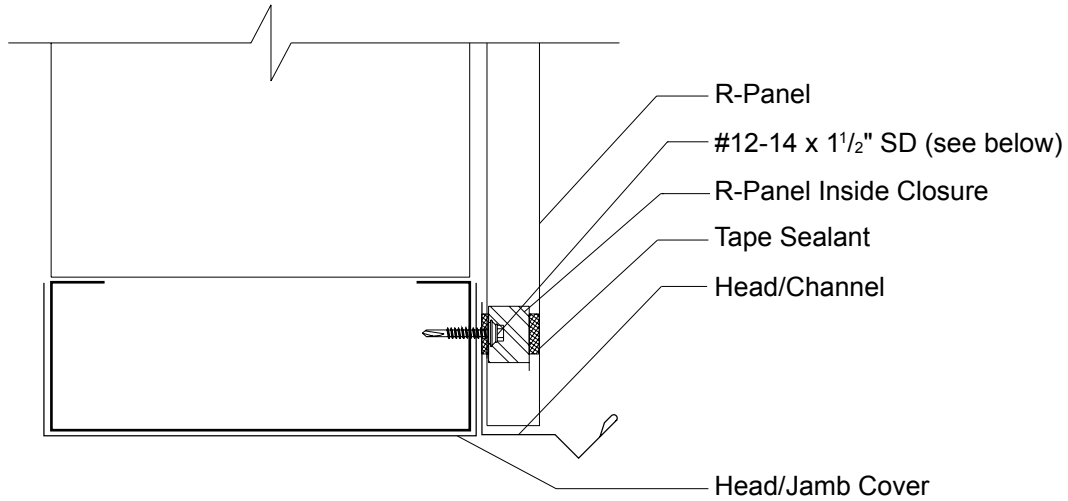

R-Panel Fastening Pattern

R-PANEL BASE DETAIL

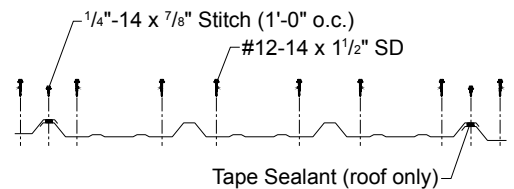
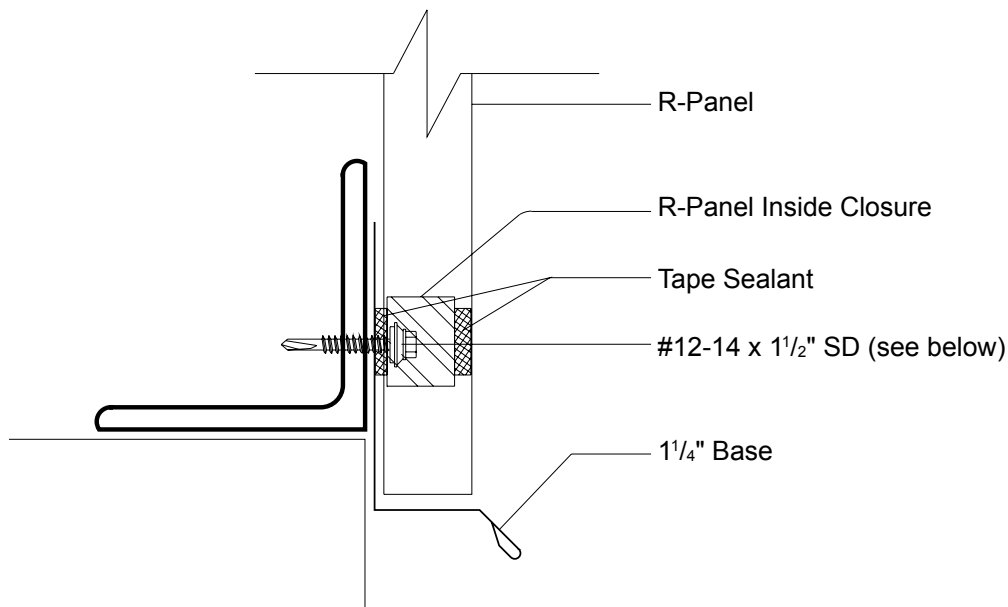

R-Panel Fastening Pattern

