

**Product Page No.**

**Panel Information**

Delta Rib Panel Profile ..... PDR-2  
 Panel Overview ..... PDR-2

**Flashing Profiles**

Eave (Direct Fasten)..... PDR-3  
 Sculptured Gutter ..... PDR-3  
 Sculptured Gutter End ..... PDR-3  
 Universal Gutter/Downspout Strap ..... PDR-3  
 Downspout..... PDR-3  
 95° Elbow ..... PDR-3  
 Downspout Bracket ..... PDR-3  
 Gutter Hanger..... PDR-3  
 Sculptured Corner Box ..... PDR-3  
 Sculptured Peak Box..... PDR-3  
 Valley ..... PDR-3  
 Sculptured Rake..... PDR-3  
 Sculptured Rake End..... PDR-3  
 Pitch Break ..... PDR-3  
 Sculptured High Side Eave..... PDR-3  
 Counter Flashing ..... PDR-4  
 Reglet Flashing..... PDR-4  
 20" Ridge/Hip Cover..... PDR-4  
 Universal Ridge Cover..... PDR-4  
 Vented Ridge Cover ..... PDR-4  
 Vent Drip..... PDR-4  
 Gravel Stop..... PDR-4  
 Inside Corner ..... PDR-4  
 Outside Corner ..... PDR-4  
 1.5" Sill/Head ..... PDR-4  
 1.5" Sill to Soffit ..... PDR-4  
 1.25" Base ..... PDR-4  
 Jamb..... PDR-4  
 Head Channel..... PDR-4  
 Head Jamb Cover..... PDR-4  
 Cleat ..... PDR-5

**Accessory Profiles**

Delta Rib Closures..... PDR-5  
 Universal Closure ..... PDR-5  
 Vent Material..... PDR-5  
 Tube Sealant ..... PDR-5  
 Tape Sealant..... PDR-5  
 Rubber Roof Jack..... PDR-5  
 Retro Roof Jack..... PDR-5  
 Rubber Roof Flashing Kit ..... PDR-5  
 Touch-Up Paint ..... PDR-5  
 Continuous Ridge Vent..... PDR-5  
 Louver with Screen..... PDR-5

**Testing Information**

Section Properties and General Information ..... PDR-6

**Design/Installation Considerations**

Fastener Installation Technique..... PDR-7  
 Fastening Information..... PDR-8  
 Condition of Substructure..... PDR-8

**Product Page No.**

**Detail Conditions**

Eave Detail ..... PDR-9  
 Gutter Detail ..... PDR-9  
 Valley Detail..... PDR-10  
 Rake Detail..... PDR-10  
 Rakewall with Counter Flashing Detail..... PDR-11  
 Endwall with Counter Flashing Detail..... PDR-11  
 Sculptured High Side Eave Detail ..... PDR-12  
 Ridge/Hip Detail..... PDR-12  
 Universal Ridge Detail ..... PDR-13  
 Gravel Stop Detail ..... PDR-13  
 Outside Corner Detail..... PDR-14  
 Inside Corner Detail..... PDR-14  
 Jamb Detail..... PDR-15  
 Head Detail..... PDR-15  
 Base Detail ..... PDR-16

**Notes**

Notes ..... PDR-16

# DELTA RIB PANEL OVERVIEW

## DELTA RIB PROFILE

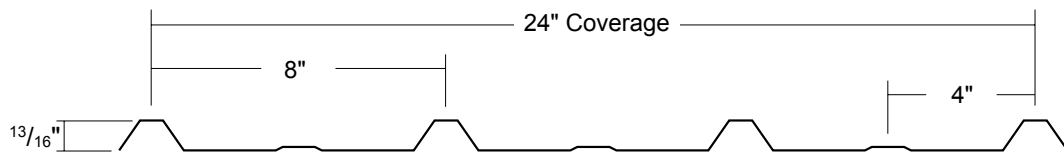

## SLOPE

The minimum recommended slope for any Delta Rib roofing panel is 3:12. Metal Sales recommends that in all roof applications sealant be used on sidelaps.

## SUBSTRATE

Delta Rib is designed to be utilized over open structural framing, but can easily be used with a solid substrate. The recommended substrate is 5/8" plywood with a 30 pound felt moisture barrier. To avoid panel distortion, use a properly aligned and uniform substructure.

## COVERAGE

Each panel has a coverage of 24".

## LENGTH

Lengths under 5'-0" are available with some cutting restrictions. Maximum recommended panel length is 45'-0". Longer panels require additional consideration in packaging, shipping, and erection. Please consult your Metal Sales branch for recommendations (see PGI-2 and PGI-3 for locations).

## AVAILABILITY

Panels are available in 30, 29, and 26 gauge. Minimum quantity may apply.

## APPLICATION

Commercial, Industrial, and Architectural panels.

## PERFORMANCE TEST

UL-2218, UL-790

## FASTENING SYSTEM

Direct Fastened (exposed).

## FASTENERS

The fastener selection guide should be consulted for choosing proper fasteners for specific applications. Quantity and type of fastener must meet necessary loading and code requirements (see PGI-12-14).

## MATERIALS

Steel grade 50 per ASTM A-792  
Steel grade 80 per ASTM A-792 or ASTM A-653

## FINISH

- ▶ \*Acrylic Coated Galvalume® (ACG) / ASTM A-792 - AZ55
- ▶ Prepainted Galvalume / ASTM A-792 - AZ50
- ▶ MS Colorfast45®

\* Differential appearance of Acrylic Coated Galvalume roofing materials is not a cause for rejection.

**EAVE (DIRECT FASTEN)**

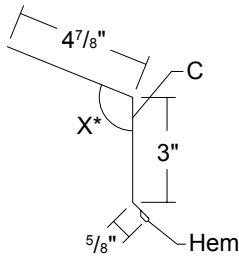

Length 10'-2" - \*Specify Slope Angle

**SCULPTURED GUTTER**

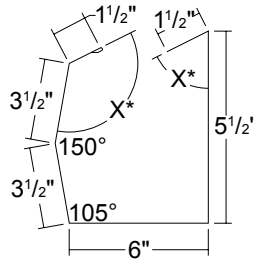

Length 10'-2", 20'-3" - \*Specify Slope Angle

**SCULPTURED GUTTER END**

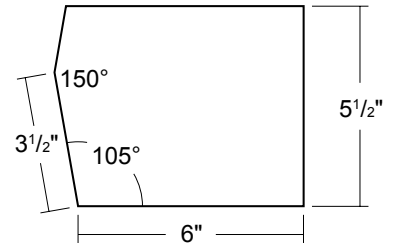

**UNIVERSAL GUTTER/ DOWNSPOUT BRACKET**

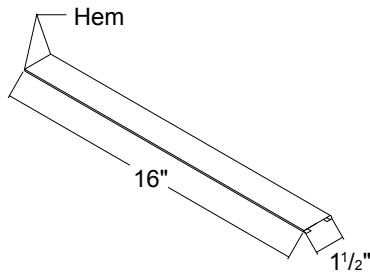

**DOWNSPOUT 6" x 4"**

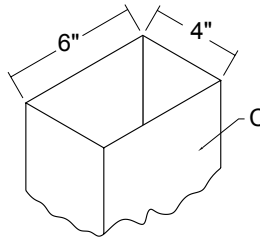

Length 10'-2", 20'-3" (Also available 4" x 3 1/2")

**95° ELBOW 6" x 4"**

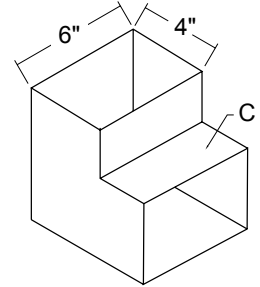

(Also available 4" x 3 1/2")

**DOWNSPOUT BRACKET**

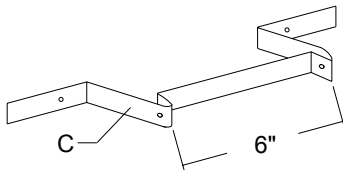

(Also available 4")

**GUTTER HANGER**

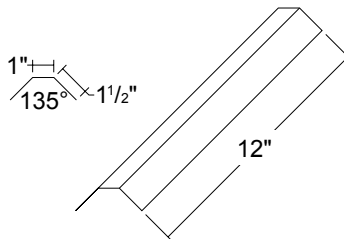

**SCULPTURED CORNER BOX**

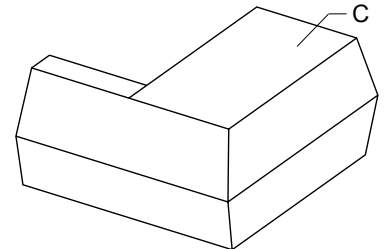

**SCULPTURED PEAK BOX**

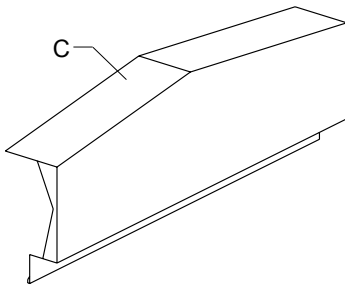

**VALLEY**

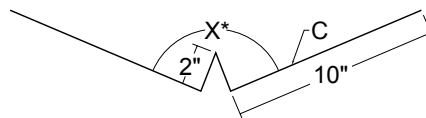

Length 10'-2", 20'-3" - \*Specify Slope Angle

**SCULPTURED RAKE**

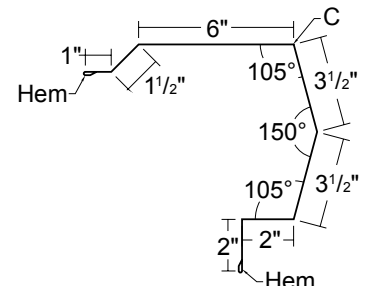

Length 10'-2", 20'-3"

**SCULPTURED RAKE END**

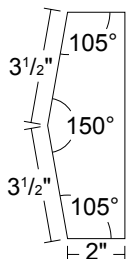

**PITCH BREAK**

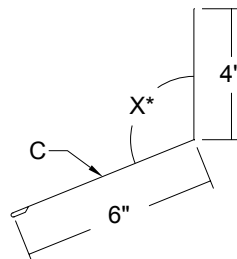

Length 10'-2" - \*Specify Slope Angle

**SCULPTURED HIGH SIDE EAVE**

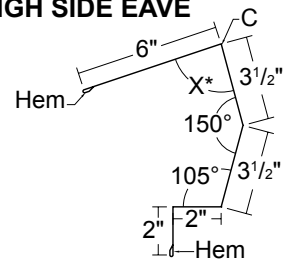

Length 10'-2", 20'-3" - \*Specify Slope Angle

# DELTA RIB FLASHING PROFILES (CONT.)

## COUNTER FLASHING

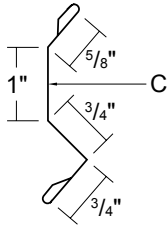

Length 10'-2"

## REGLET FLASHING

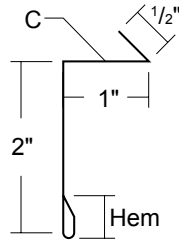

Length 10'-2"

## 20" RIDGE/HIP COVER

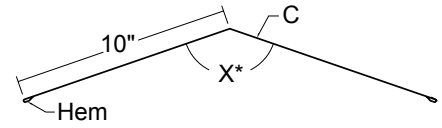

Length 10'-2", 20'-3" - \*Specify Slope Angle

## UNIVERSAL RIDGE COVER

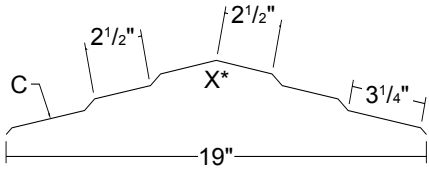

Length 10'-2" - \*Specify Slope Angle

## VENTED RIDGE COVER

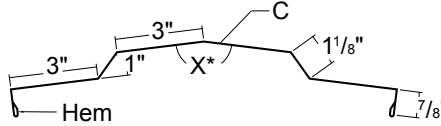

Length 10'-2", 20'-3" - \*Specify Slope Angle

## VENT DRIP

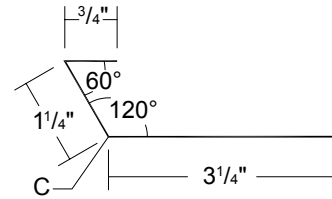

Length 10'-2"

## GRAVEL STOP

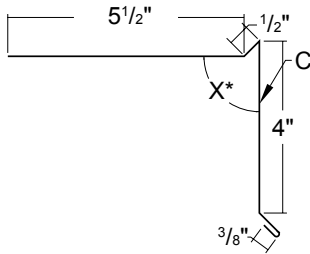

Length 10'-2", 20'-3" - \*Specify Slope Angle

## INSIDE CORNER

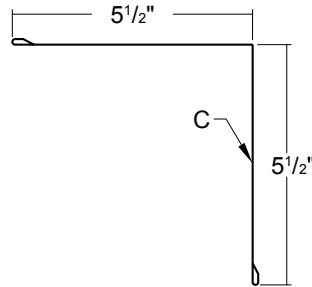

Length 10'-2", 20'-3"

## OUTSIDE CORNER

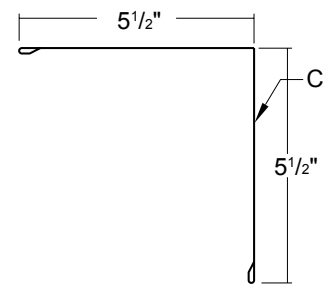

Length 10'-2", 20'-3"

## 1.5" SILL/HEAD

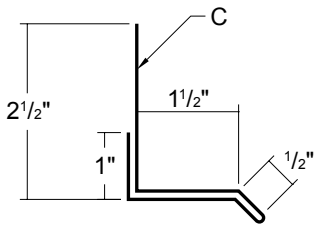

Length 10'-2"

## 1.5" SILL TO SOFFIT

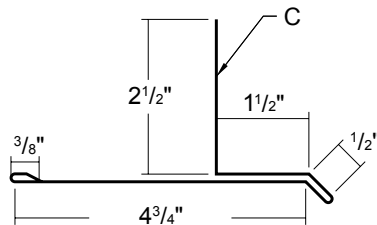

Length 10'-2"

## 1.25" BASE

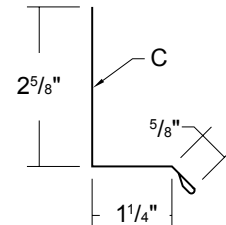

Length 10'-2"

## JAMB

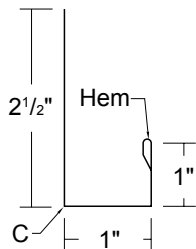

Length 7'-3", 10'-2", 14'-2"

## HEAD CHANNEL

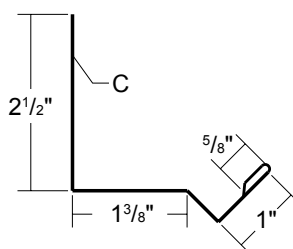

Length 10'-2"

## HEAD/JAMB COVER

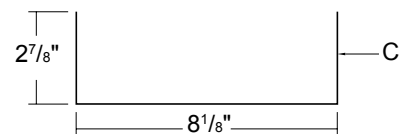

Length 10'-2", 14'-2"

# DELTA RIB FLASHING PROFILES (CONT.) / ACCESSORY PROFILES

## CLEAT

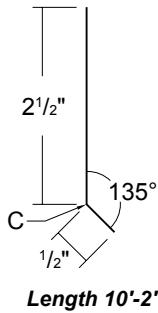

C- Indicates color side of flashing.

## DELTA-RIB ACCESSORY PROFILES

### DELTA RIB CLOSURES

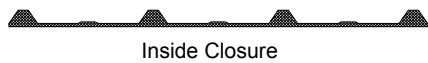

Polyethylene Foam

### UNIVERSAL CLOSURE

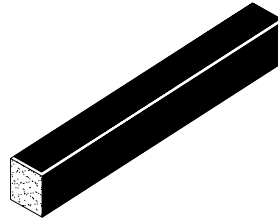

1" x 1 1/2" x 50' Polyethylene Foam  
1" x 1 1/2" x 10' Polyethylene Foam

### VENT MATERIAL

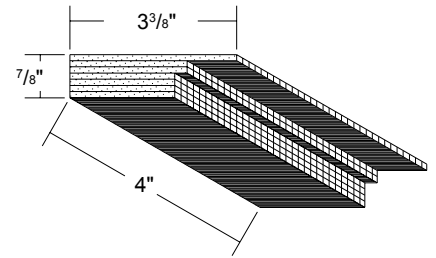

### TUBE SEALANT

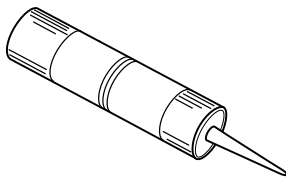

10.3 oz. Cartridge  
Urethane

### TAPE SEALANT

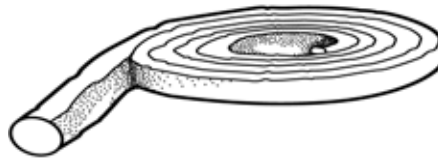

3/8" X 3/32" X 50'  
Single Bead  
Butyl - Gray

### RUBBER ROOF JACK

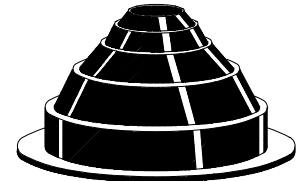

MINI (1/4" to 1/8" O.D. Pipe)  
#2 (1 3/4" to 3" O.D. Pipe)  
#4 (3" to 6" O.D. Pipe)  
#6 (6" to 9" O.D. Pipe)  
#8 (7" to 13" O.D. Pipe)

### RETRO ROOF JACK

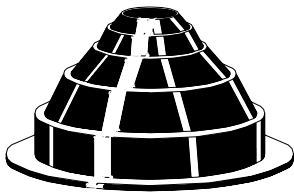

#801<sub>RETRO</sub> (3/4" to 2 3/4" O.D. Pipe)  
#802<sub>RETRO</sub> (2" to 7 1/4" O.D. Pipe)  
#803<sub>RETRO</sub> (3 1/4" to 10" O.D. Pipe)

### RUBBER ROOF FLASH KIT

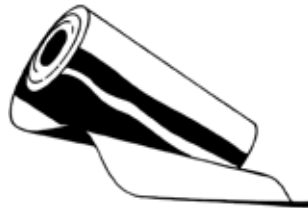

12" x 50'-0" Flash Kit  
18" x 50'-0" Flash Kit

### TOUCH-UP PAINT

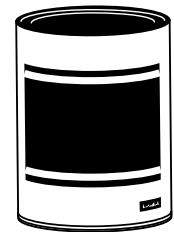

Available in pints  
PVDF / MS Colorfast45

### CONTINUOUS RIDGE VENT

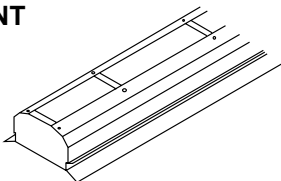

9" x 10', 12" x 10'

### LOUVER WITH SCREEN

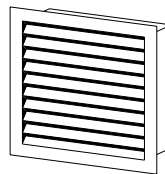

3' x 3', 3' x 4'

# DELTA RIB SECTION PROPERTIES AND LOAD TABLES

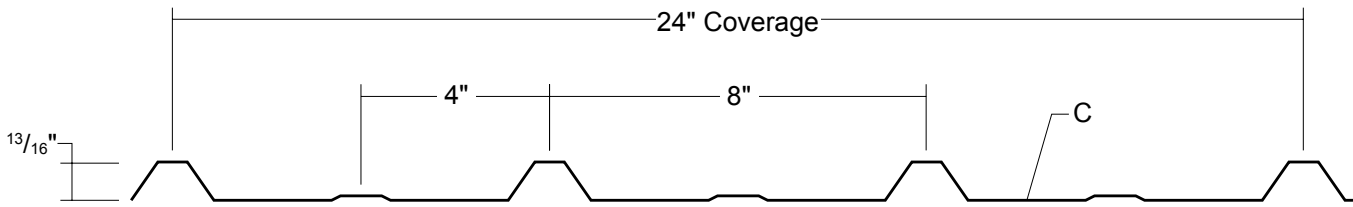

SECTION PROPERTIES								ALLOWABLE UNIFORM LIVE LOADS PSF (3 or More Equal Spans)											
Ga.	Width (in.)	Yield KSI	Weight PSF	Top in Compression		Bottom in Compression		Inward (Gravity / Deflection) Load						Outward Uplift (Stress) Load					
				Ixx In <sup>4</sup> /ft	Sxx In <sup>3</sup> /ft	Ixx In <sup>4</sup> /ft	Sxx In <sup>3</sup> /ft	2'	3'	4'	5'	6'	7'	2'	3'	4'	5'	6'	7'
26	24"	80	0.80	0.0160	0.0275	0.0135	0.0280	185	85	45	23	13	8	182	84	45	23	13	8
24	24"	50	1.05	0.0230	0.0399	0.0190	0.0378	213	97	55	30	18	11	225	102	58	30	18	11

- Theoretical section properties have been calculated per AISI 2001. "Specifications for the Design of Cold-formed Steel Structural Members." Ixx and Sxx are effective section properties for deflection and bending.
- Allowable load is calculated in accordance with AISI 2001 specifications considering bending, shear, combined bending and shear and deflection. Allowable load considers the worst case of 3 and 4 equal span conditions. Allowable load does not address web crippling, fasteners/support connection, or uplift testing. Panel weight is not considered.
- Deflection consideration is limited by a maximum deflection ratio of L/180 of span.
- Allowable loads do not include a 1/3 stress increase in uplift.

## ATTACHMENT DETAIL

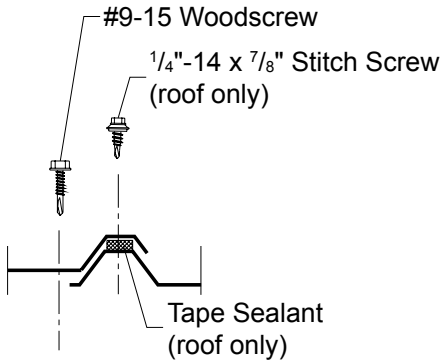

## FASTENING PATTERN

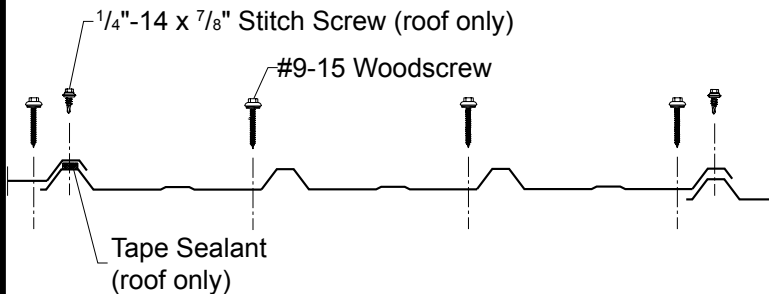

## GENERAL INFORMATION

### ► Slope

The minimum recommended slope for Delta Rib roofing panel is 3:12. Metal Sales recommends that in all roof applications, sealants and stitch screws be used on all sidelaps.

### ► Substructure

Delta Rib is designed to be utilized over open structural framing, but can easily be used with a solid substrate. To avoid panel distortion, use a properly aligned and uniform substructure.

### ► Coverage

Delta Rib panels are available in a 13/16" rib height with a coverage width of 24".

### ► Length

Minimum factory cut length is 5'-0". Maximum recommended panel length is 40'-0". Longer panels require additional consideration in packaging, shipping, and erection. Please consult Metal Sales for recommendations.

### ► Fasteners

The fastener selection guide should be consulted for choosing the proper fastener for specific applications. Quantity and type of fastener must meet necessary loading and code requirements.

*NOTE: All panels are subject to surface distortion due to improperly installed fasteners. Over-driven fasteners will cause stress and induce oil canning across the face of the panel at or near the point of attachment.*

### ► Availability

*Finishes:* MS Colorfast45® and Acrylic Coated Galvalume®  
*Gauge:* 26 ga standard, 24 ga optional

**FASTENER INSTALLATION TECHNIQUE**

**USING NAILS:**

If nails are used as a fastening method, it is best to use a painted or galvanized steel ring shank nail with a flat neoprene washer. Nails should penetrate the wood support to a depth of at least 1/4", but should not be too long as to protrude completely through the support. Nails must not be driven to tight. Overdriving may cause damage to washers and/or the steel sheet. Nails should be driven perpendicular to the wood support, unless the manufacturer's directs otherwise. Typically 11lb of nails should be used per square for 2' wide panels and 2 lbs of nails should be used per square for 3' wide panels.

**USING SCREWS:**

If screws are used as a fastening method, it is best to use a painted or plated screw, Type A or driller tip with a flat rubber washer. The correct screw gun is also important to the proper installation of self-drilling or self-tapping screws. A tool with the appropriate speed and torque setting (as recommended by the fastener manufacturer) will help prevent fastener thread strip-out and possible damage to the panel or its coating. Typically 40 screws should be used per square for 2' wide panels and 80 screws should be used per square for 3' wide panels.

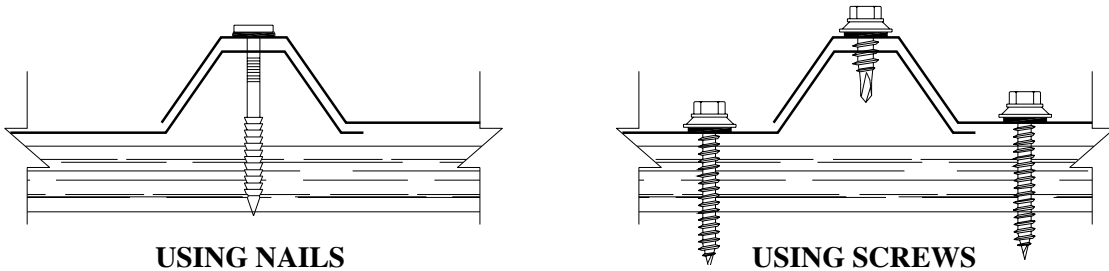

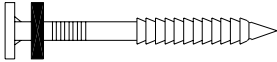
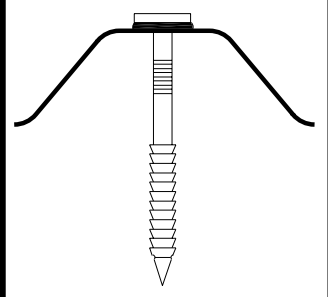
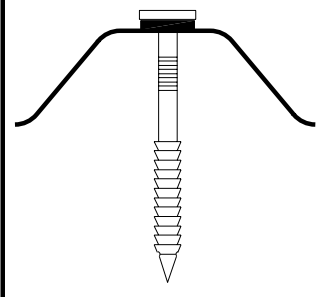
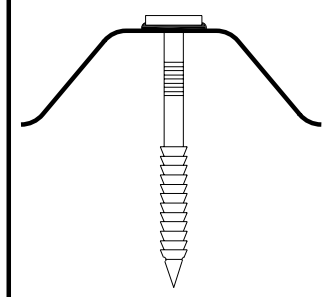
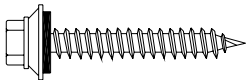
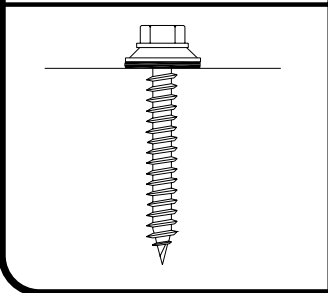
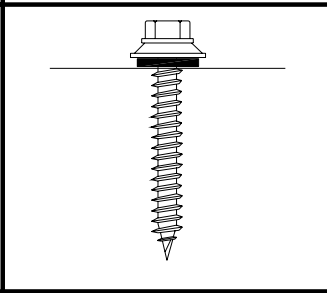
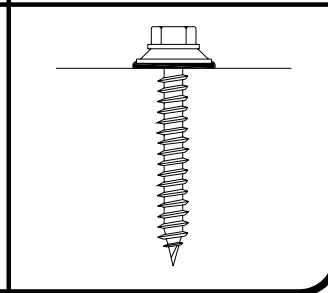
	<b>CORRECT</b> Sealing material slightly visible at edge of washer. Assembly is water tight.	<b>TOO LOOSE</b> Sealing material is not visible; not enough compression to seal.	<b>TOO TIGHT</b> Washer is deformed; sealing material pressed beyond fastener edge.
			
			

**SEATING THE WASHER** - Apply sufficient torque to seat the washer - do not overdrive the fastener.

**TO PREVENT WOBBLING** - Make sure fastener head is completely engaged in the socket. If the head does not go all the way in the socket - tap the magnet deeper into the socket to allow full engagement. Metal chips will build up from drilling and should be removed from time to time.

**PROTECT DRILL POINT** - Push only hard enough on the screw gun to engage clutch. This prevents excess friction and burn out of the drill point. Correct pressure will allow screw to drill and tap without binding.

## FASTENING PATTERN

Note: Fastening patterns should be checked to meet applicable loading conditions.

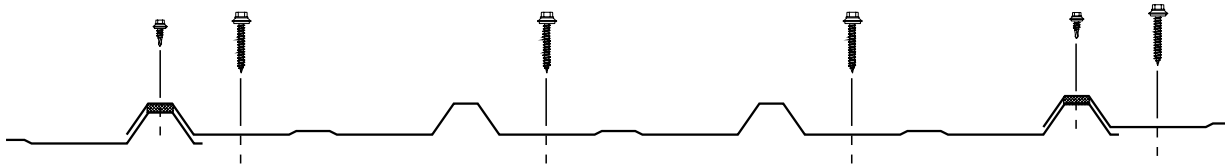
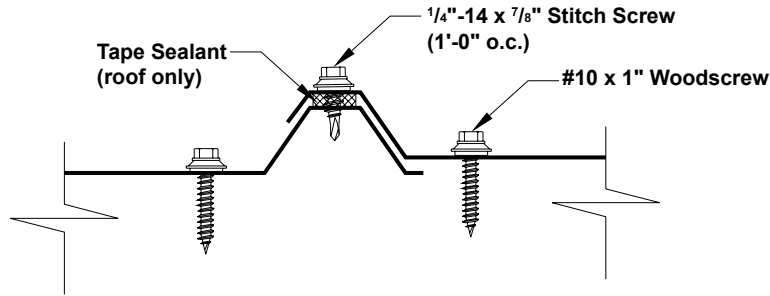

**Typical Screw Fastening Pattern**



**Typical Nail Fastening Pattern**

## CONDITION OF SUBSTRUCTURE

Whether over solid substrate or open structural framing, panel distortion may occur if not applied over properly aligned and uniform substructure.

The installer should check the roof deck for squareness before installing Delta Rib Panels. Several methods can be used to verify squareness of the structure for proper installation of the panels.

**METHOD "A"** - One method for checking the roof for squareness is to measure diagonally across one slope of the roof from similar points at the ridge and eave and obtain the same dimension.

**METHOD "B"** - The 3-4-5 triangle system may also be used. To use this system measure a point from the corner along the edge of the roof at a module of three (3). Measure a point from the same corner along another edge at a module of four (4). Then by measuring diagonally between the two points established, the dimension should be exactly a module of five (5) to have a square corner. Multiple uses of this system may be required to determine building squareness. If the endwall cannot be made square, the roof system cannot be installed as shown in these instructions.

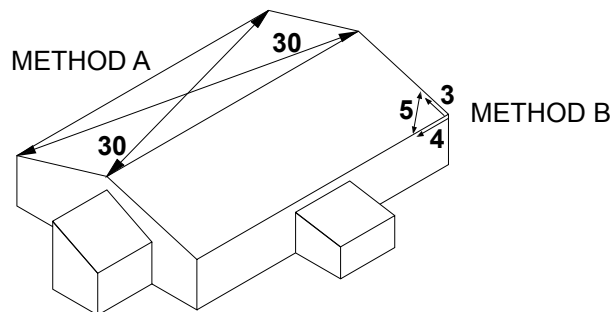



# DELTA RIB EAVE DETAIL

3:12 Slope  
Minimum

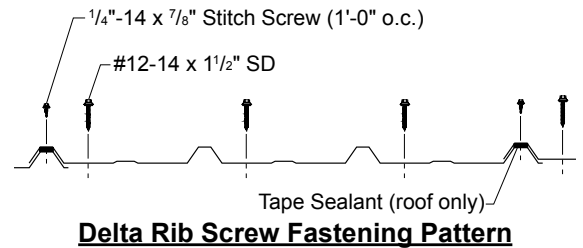
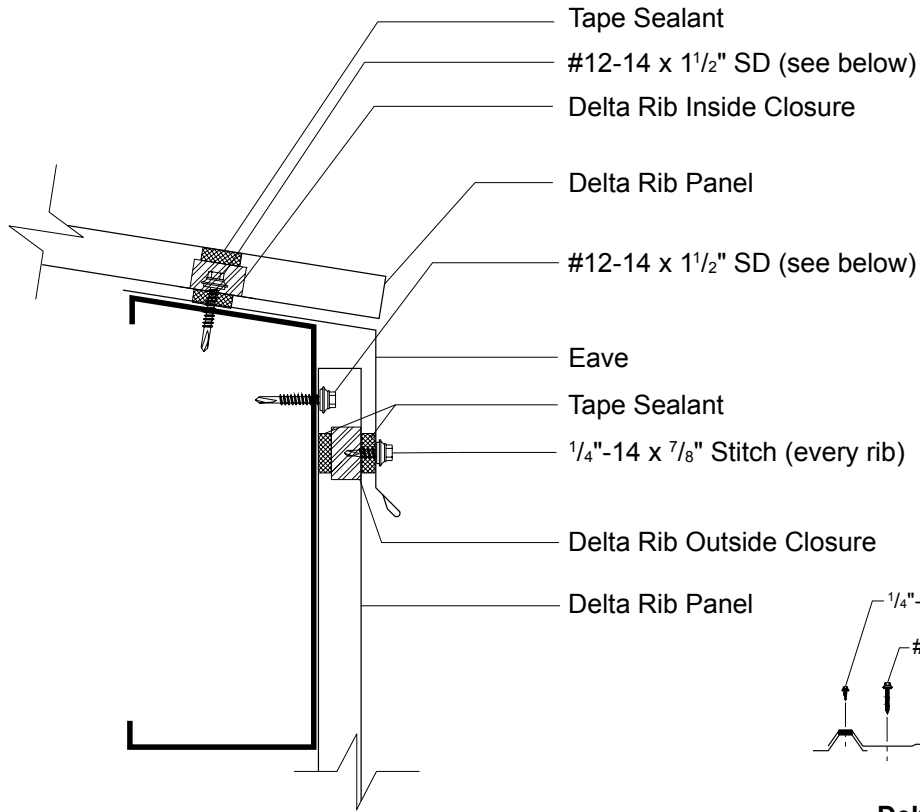

# DELTA-RIB GUTTER DETAIL

3:12 Slope  
Minimum

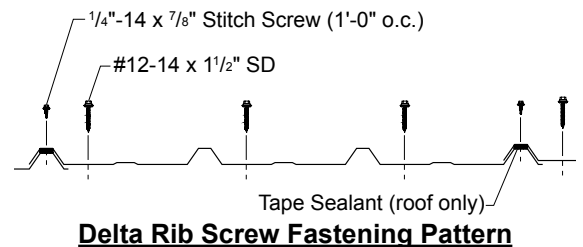
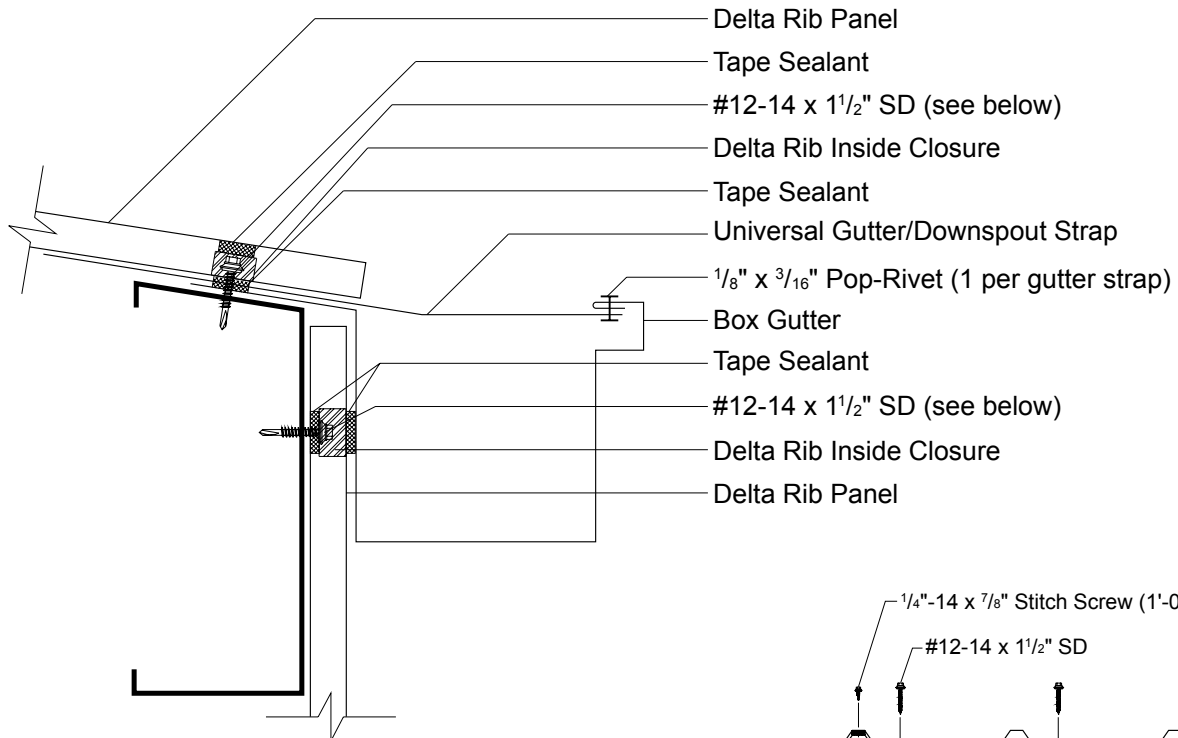

# DELTA RIB VALLEY DETAIL

3:12 Slope  
Minimum

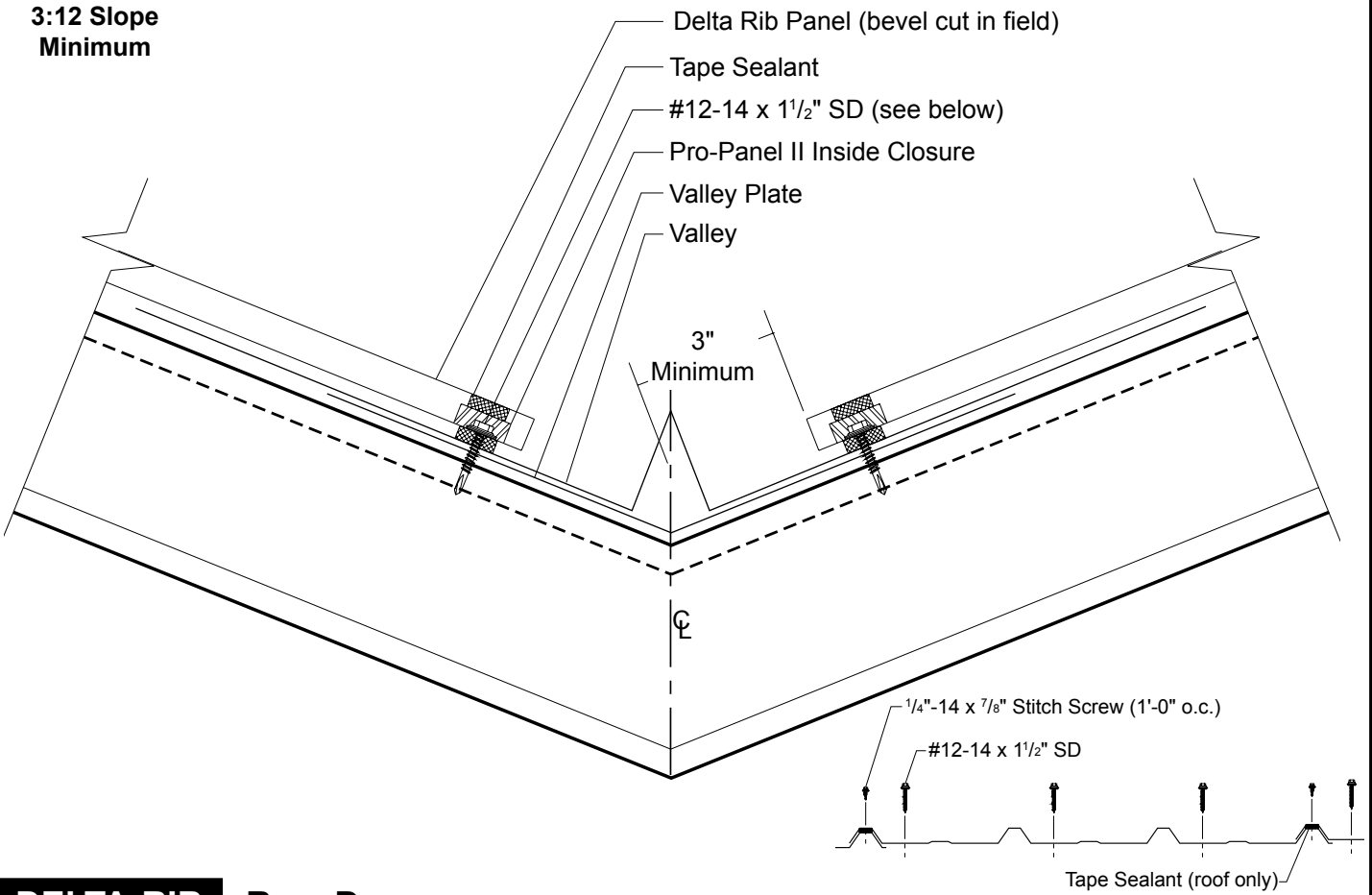

# DELTA-RIB RAKE DETAIL

3:12 Slope  
Minimum

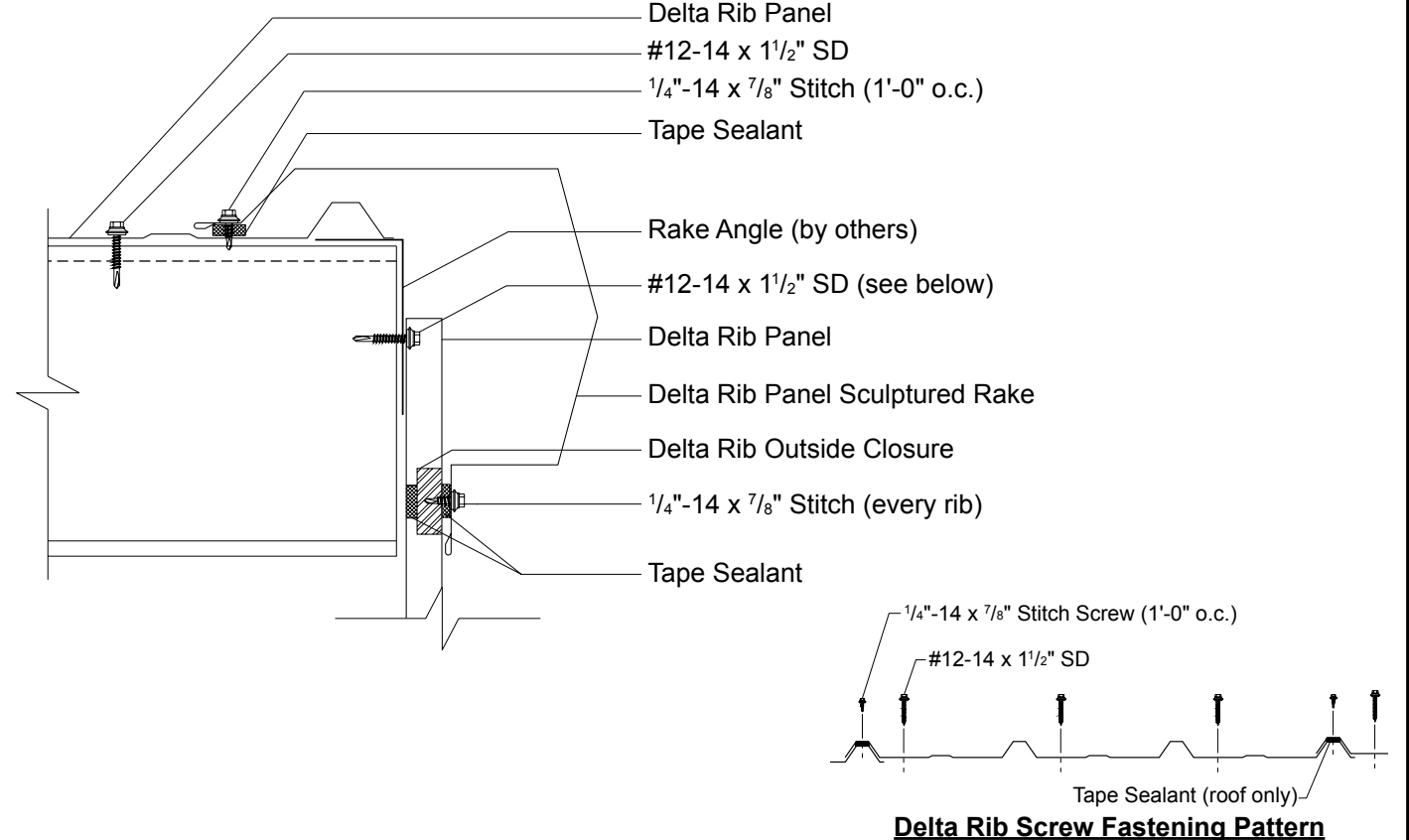

# DELTA RIB

## RAKEWALL WITH COUNTER FLASHING DETAIL

3:12 Slope  
Minimum

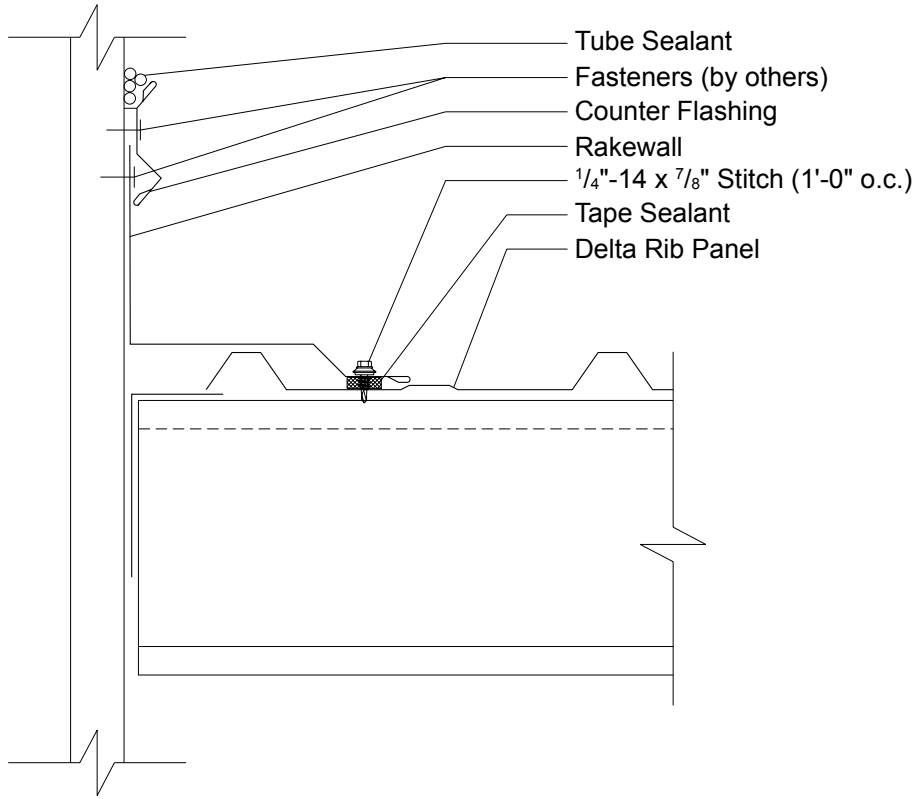

# DELTA-RIB

## ENDWALL WITH COUNTER FLASHING DETAIL

3:12 Slope  
Minimum

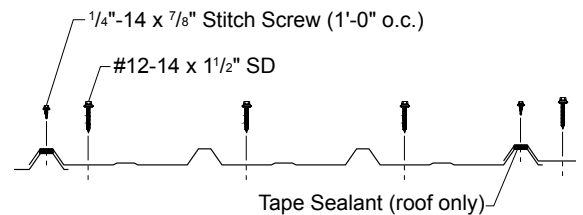
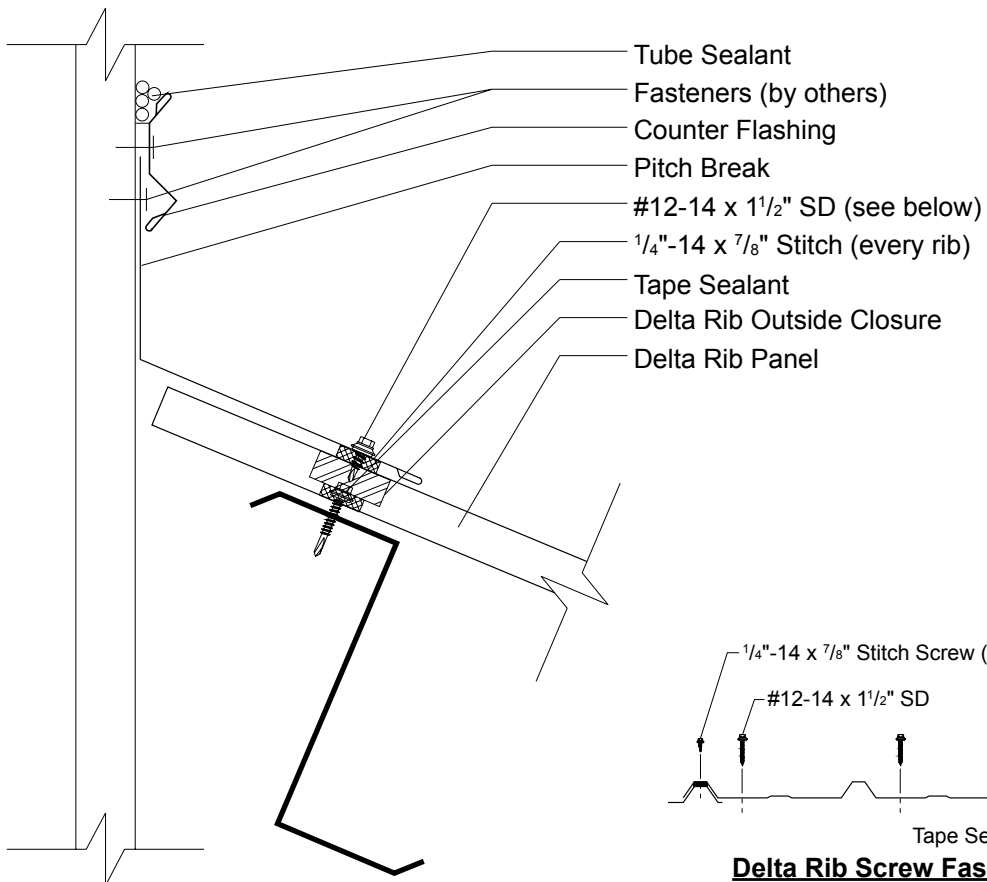

**Delta Rib Screw Fastening Pattern**

# DELTA RIB SCULPTURED HIGH SIDE EAVE DETAIL

3:12 Slope  
Minimum

- Delta Rib Panel
- 1/4"-14 x 7/8" Stitch (every rib)
- Tape Sealant
- Delta Rib Outside Closure
- Tape Sealant
- Sculptured High Side Eave
- #12-14 x 1 1/2" SD (see below)

- Tape Sealant
- 1/4"-14 x 7/8" Stitch (every rib)

- Delta Rib Outside Closure
- Delta Rib Panel
- 1/4"-14 x 7/8" Stitch Screw (1'-0" o.c.)
- #12-14 x 1 1/2" SD

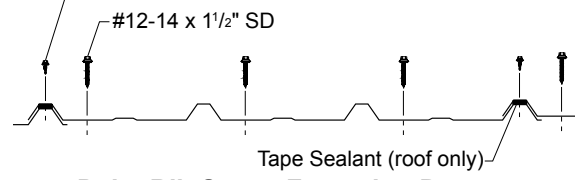

**Delta Rib Screw Fastening Pattern**

# DELTA-RIB RIDGE/HIP DETAIL

3:12 Slope  
Minimum

- Delta Rib Panel
- #12-14 x 1 1/2" SD (see below)
- 1/4"-14 x 7/8" Stitch Screw (every rib)
- Tape Sealant
- Classic Rib Outside Closure
- 20" Ridge/Hip Cover

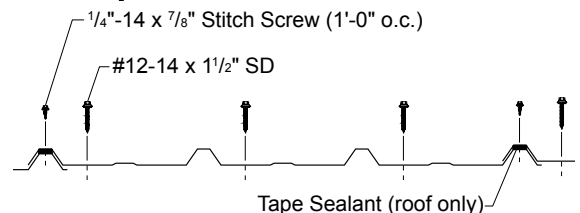

**Delta Rib Screw Fastening Pattern**

# DELTA RIB UNIVERSAL RIDGE DETAIL

3:12 Slope  
Minimum

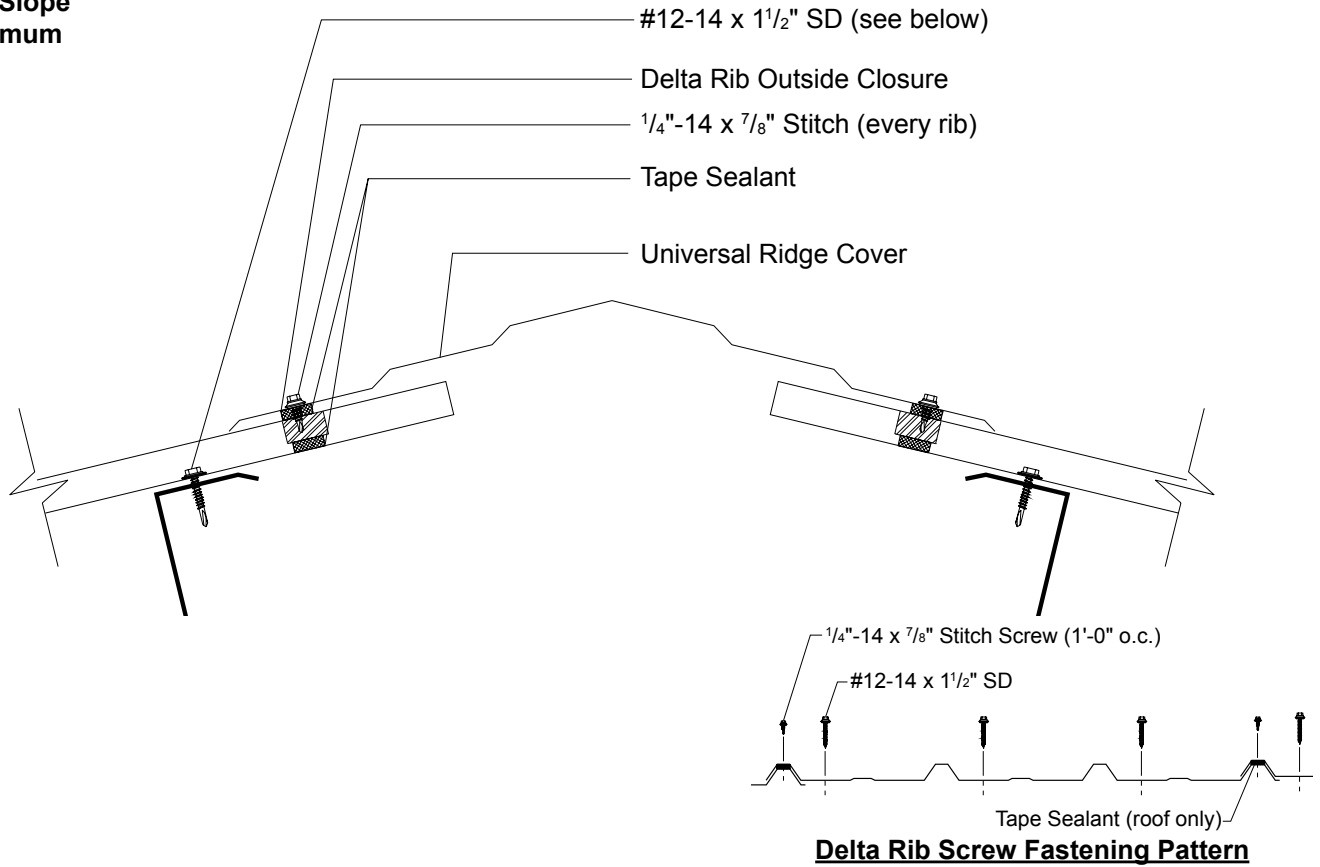

# DELTA-RIB GRAVEL STOP DETAIL

3:12 Slope  
Minimum

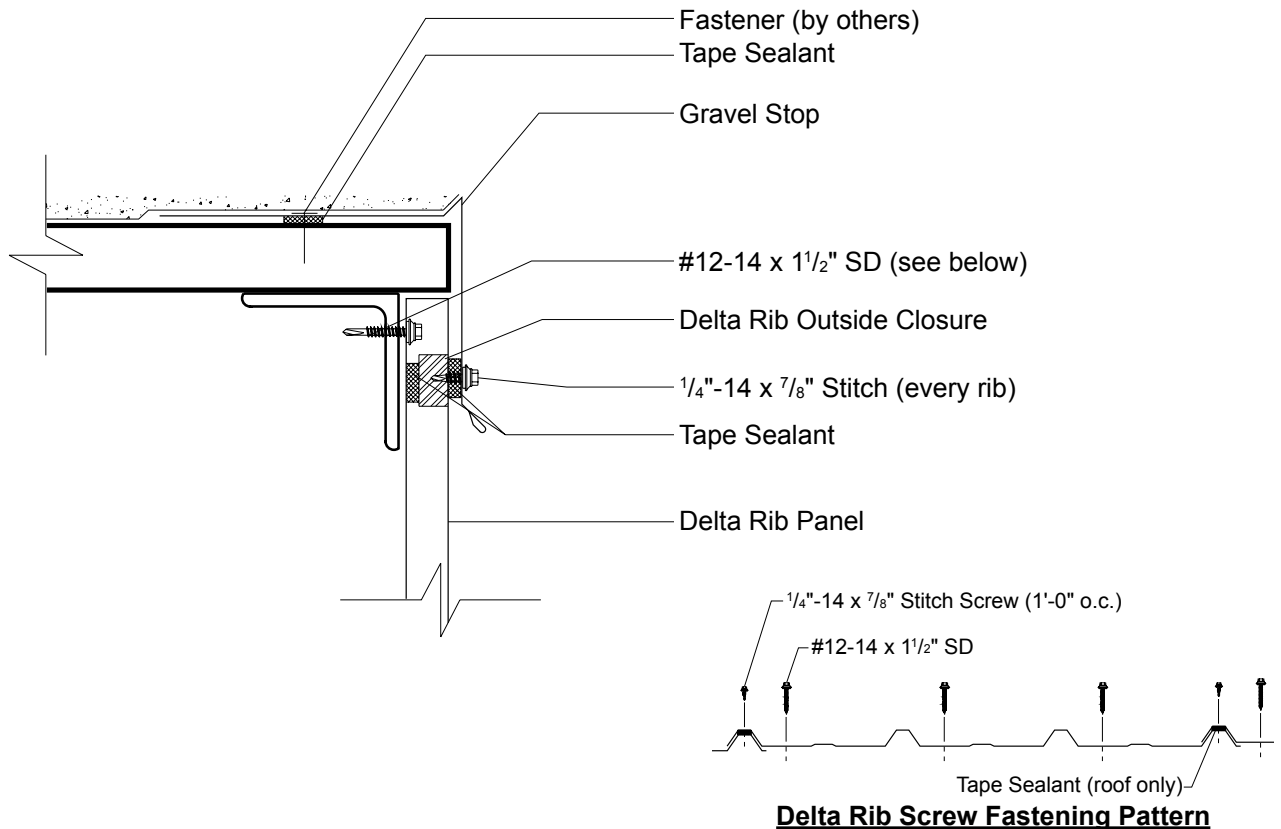

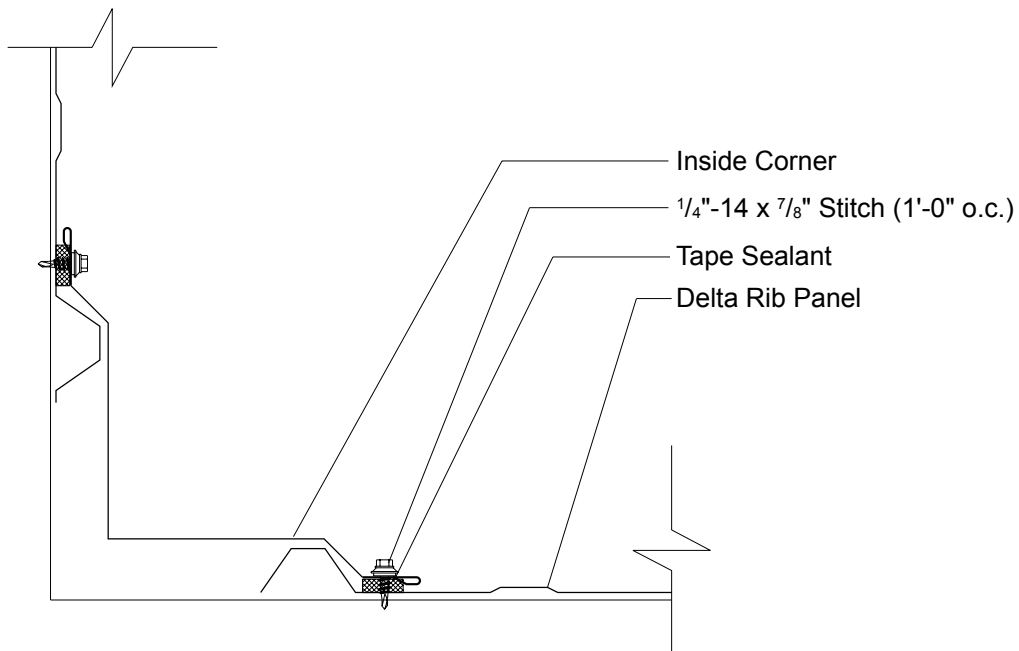
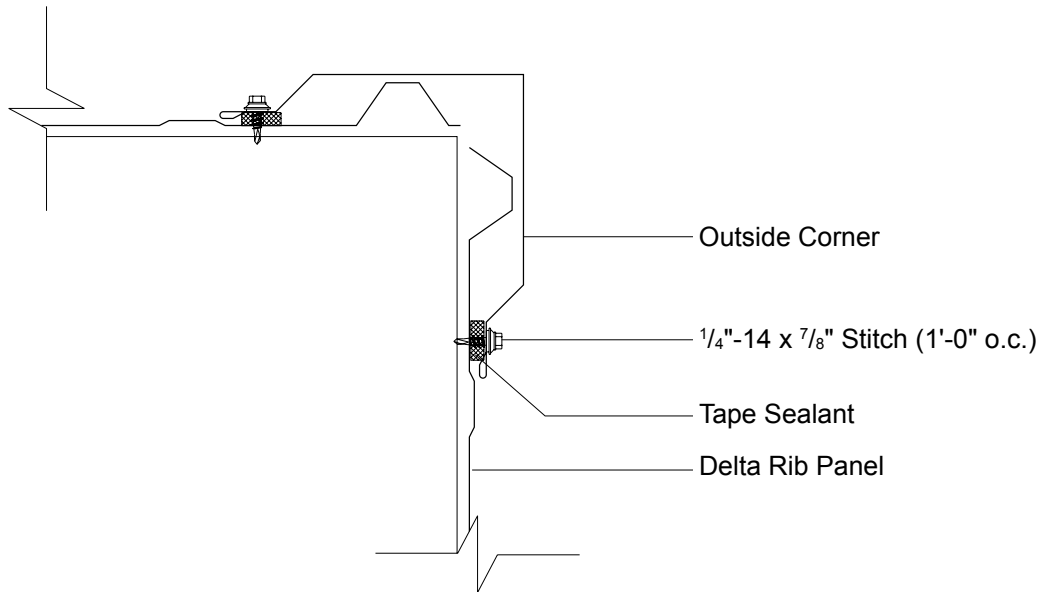

# DELTA RIB JAMB DETAIL

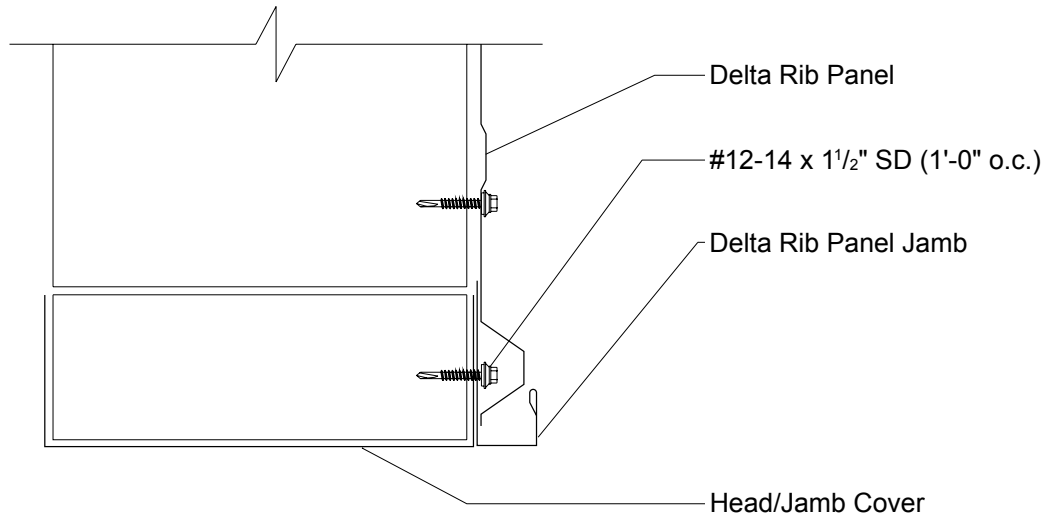

# DELTA-RIB HEAD DETAIL

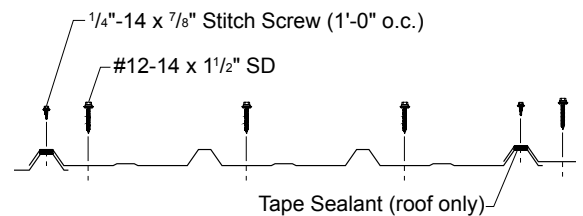
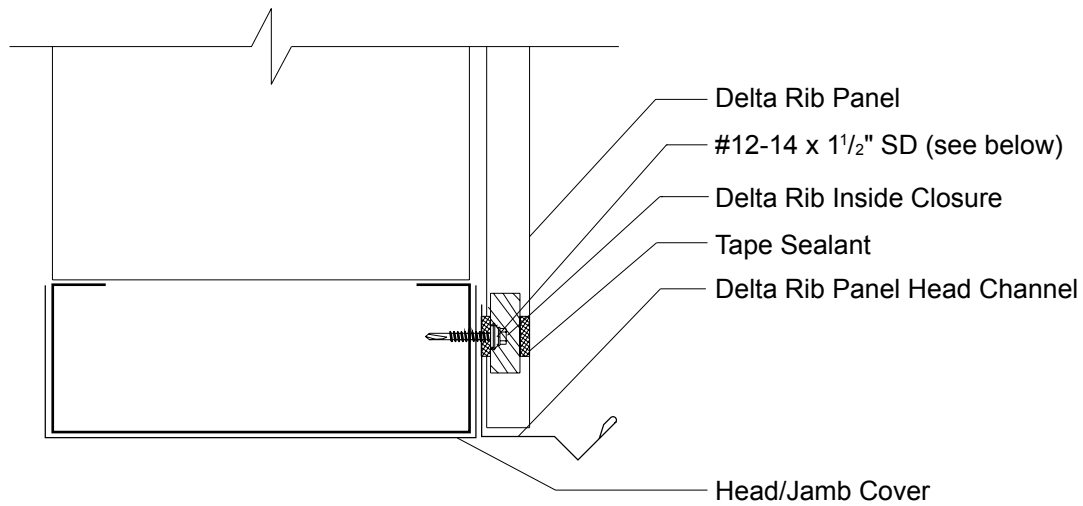

**Delta Rib Screw Fastening Pattern**

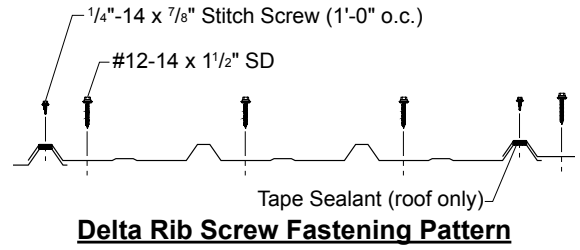
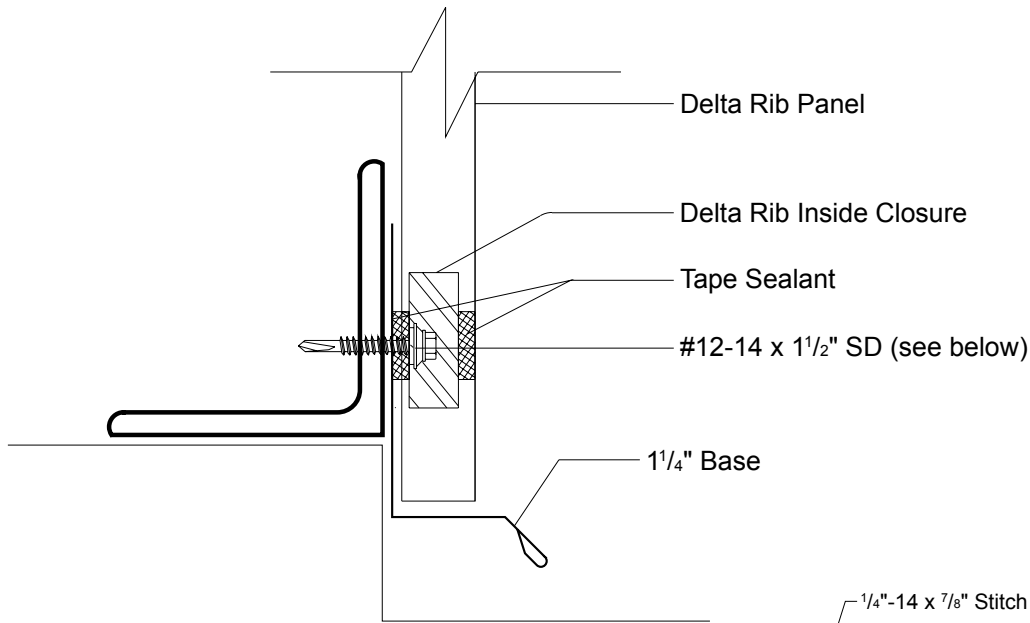

**DELTA-RIB**

**NOTES**
