

<b>Product</b>	<b>Page No.</b>
<b>Panel Information</b>	
Pro-Panel II Panel Profile .....	PPP-2
Panel Overview .....	PPP-2
<b>Flashing Profiles</b>	
Eave (Direct Fasten).....	PPP-3
Cleat .....	PPP-3
Box Gutter .....	PPP-3
Box Gutter End .....	PPP-3
Universal Gutter/Downspout Strap.....	PPP-3
6" x 4" Downspout .....	PPP-3
6" x 4" 95° Elbow .....	PPP-3
Downspout Bracket .....	PPP-3
Valley .....	PPP-3
Pro-Panel II Rake .....	PPP-3
Rakewall .....	PPP-3
Pitch Break .....	PPP-3
Peak .....	PPP-3
11" Ridge/Hip Cover .....	PPP-3
20" Ridge/Hip Cover.....	PPP-3
Vented Ridge Cover .....	PPP-4
Vent Drip.....	PPP-4
Pro-Panel II Inside Corner.....	PPP-4
Pro-Panel II Outside Corner .....	PPP-4
1.5" Sill/Head.....	PPP-4
1.5" Sill to Soffit .....	PPP-4
Head Jamb Cover.....	PPP-4
Pro-Panel II Jamb.....	PPP-4
1 1/4" Base .....	PPP-4
Gravel Stop.....	PPP-4
Sculptured High Side Eave.....	PPP-4
Universal Ridge Cover.....	PPP-4
<b>Accessory Profiles</b>	
Pro-Panel II Closures .....	PPP-5
Universal Closure .....	PPP-5
Pro-Panel II Light Transmitting Panel .....	PPP-5
Tube Sealant .....	PPP-5
Tape Sealant.....	PPP-5
Rubber Roof Jack.....	PPP-5
Retro Roof Jack.....	PPP-5
Rubber Roof Flashing Kit .....	PPP-5
Touch-Up Paint .....	PPP-5
Continuous Ridge Vent.....	PPP-5
Pro-Panel II Panel Shear.....	PPP-5
Vent Material.....	PPP-5
Louver with Screen.....	PPP-5
<b>Testing Information</b>	
Section Properties and General Information .....	PPP-6
<b>Design/Installation Considerations</b>	
Fastener Installation Technique.....	PPP-7
Condition of Substructure.....	PPP-7
Fastening Information.....	PPP-8

<b>Product</b>	<b>Page No.</b>
<b>Detail Conditions</b>	
Eave Detail .....	PPP-9
Box Gutter Detail .....	PPP-9
Valley Detail.....	PPP-10
Rake Detail .....	PPP-10
Rakewall Detail.....	PPP-11
Endwall Detail.....	PPP-11
High Side Eave Detail.....	PPP-12
20" Ridge/Hip Detail .....	PPP-12
Ridge Detail .....	PPP-13
Gravel Stop Detail .....	PPP-13
Outside Corner Detail.....	PPP-14
Inside Corner Detail.....	PPP-14
Jamb Detail.....	PPP-15
Head Detail.....	PPP-15
Base Detail .....	PPP-16
<b>Notes</b>	
Notes .....	PPP-16

# PRO-PANEL II® PANEL OVERVIEW

## PANEL PROFILE

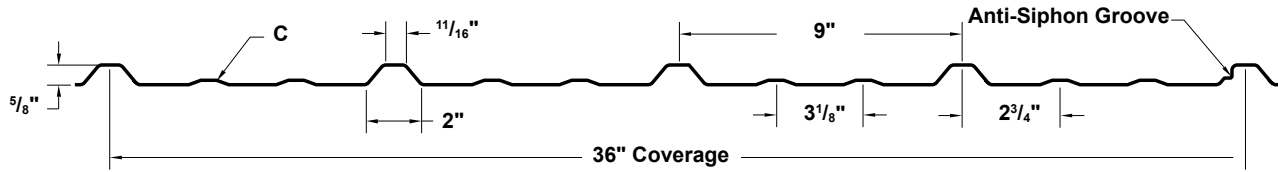

## SLOPE

The minimum recommended slope for Pro-Panel II roof panels is 3:12.

## SUBSTRATE

Pro-Panel II is designed to be utilized over open structural framing, but can easily be used with a solid substrate. The recommended substrate is  $\frac{5}{8}$ " plywood with a 30 pound felt moisture barrier. To avoid panel distortion, use a properly aligned and uniform substructure.

## COVERAGE

Pro-Panel II panels are available in a 36" width with a  $\frac{5}{8}$ " rib height.

## LENGTH

Lengths under 5'-0" are available with some cutting restrictions. Maximum recommended panel length is 45'-0". Longer panels require additional consideration in packaging, shipping, and erection. Please consult your Metal Sales branch for recommendations (see PGI-2 and PGI-3 for locations).

## AVAILABILITY

Pro-Panel II panels are available in 29 and 26 gauge.

## APPLICATION

Agricultural, Commercial and Industrial Panel

## PERFORMANCE TEST

UL 2218, UL 790, UL 263 and Florida Approval

## FASTENING SYSTEM

Direct Fasten (exposed)

## FASTENERS

The fastener selection guide should be consulted for choosing proper fasteners for specific applications. Quantity and type of fastener must meet necessary loading and code requirements (see PGI-12 through PGI-14).

## MATERIALS

29 and 26 gauge steel: Grade 80 per ASTM A 792

## FINISH

- ▶ \*Acrylic Coated Galvalume® (ACG), AZ55 per ASTM A 792
- ▶ Prepainted Galvalume®, AZ50 per ASTM A 792
- ▶ MS Colorfast45®

\* Differential appearance of Acrylic Coated Galvalume® roofing materials is not a cause for rejection.

**EAVE (DIRECT FASTEN)**

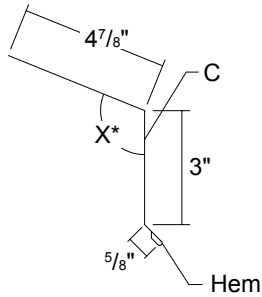

Length 10'-2" - \*Specify Slope Angle

**CLEAT**

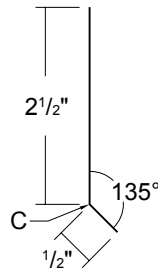

Length 10'-2"

**BOX GUTTER**

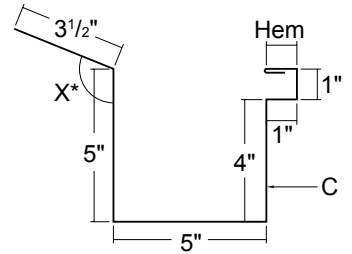

Lengths 10'-2" and 20'-3"  
\*Specify Slope Angle

**BOX GUTTER END**

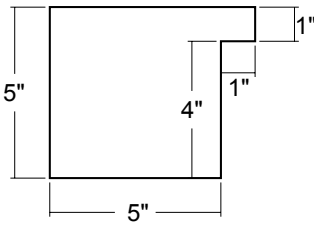

**UNIVERSAL GUTTER/  
DOWNSPOUT BRACKET**

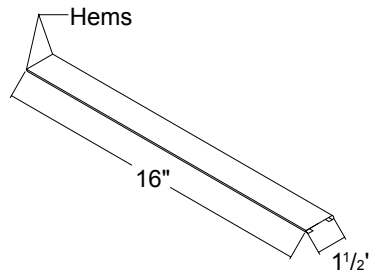

**6" x 4" DOWNSPOUT**

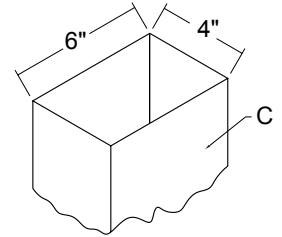

Lengths 10'-2" and 20'-3"  
(4" x 3 1/2" is also available)

**6" x 4" 95° ELBOW**

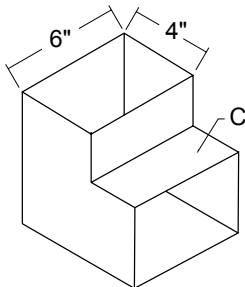

(4" x 3 1/2" is also available)

**DOWNSPOUT BRACKET**

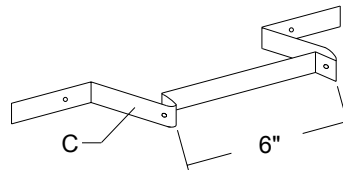

(4" is also available)

**VALLEY**

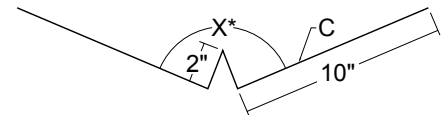

Lengths 10'-2" and 20'-3"  
\*Specify Slope Angle

**PRO-PANEL II RAKE**

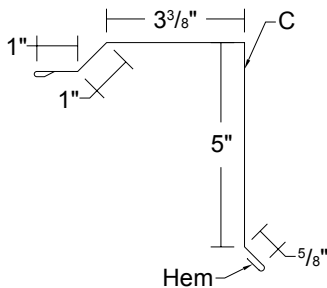

Lengths 10'-2" and 20'-3"

**RAKEWALL**

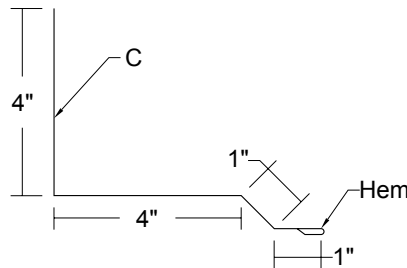

Length 10'-2"

**PITCH BREAK**

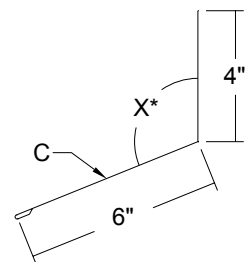

Length 10'-2" - \*Specify Slope Angle

**PEAK**

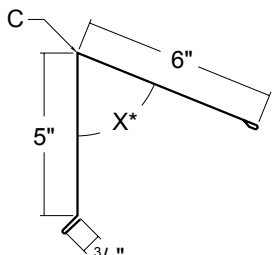

Lengths 10'-2" and 20'-3"  
\*Specify Slope Angle

**11" RIDGE/HIP COVER**

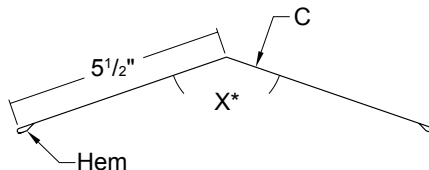

Lengths 10'-2" and 20'-3"  
\*Specify Slope Angle

**20" RIDGE/HIP COVER**

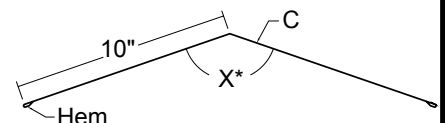

Lengths 10'-2" and 20'-3"  
\*Specify Slope Angle

# PRO-PANEL II® FLASHING PROFILES (CONT.)

## VENTED RIDGE COVER

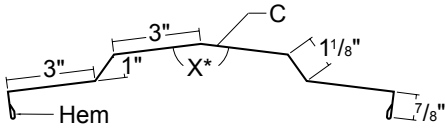

Lengths 10'-2" and 20'-3"  
\*Specify Slope Angle

## VENT DRIP

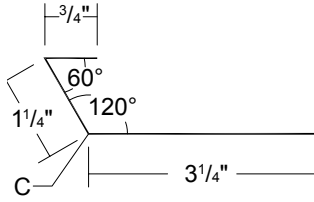

Length 10'-2"

## PRO-PANEL II INSIDE CORNER

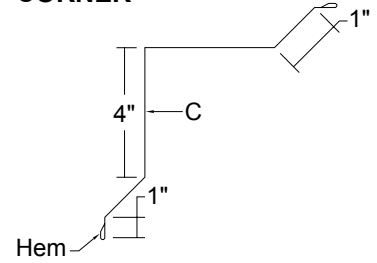

Lengths 10'-2", 14'-2" and 20'-3"

## PRO-PANEL II OUTSIDE CORNER

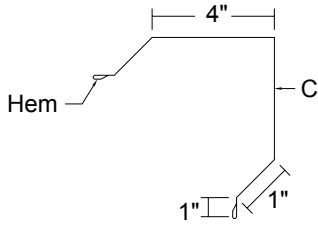

Lengths 10'-2", 14'-2" and 20'-3"

## 1.5" SILL/HEAD

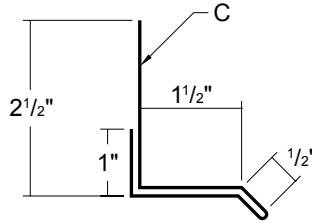

Length 10'-2"

## 1.5" SILL TO SOFFIT

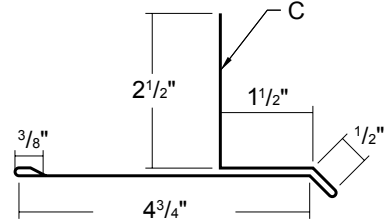

Length 10'-2"

## HEAD/JAMB COVER

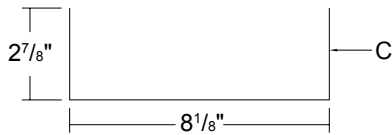

Lengths 10'-2" and 14'-2"

## PRO-PANEL II JAMB

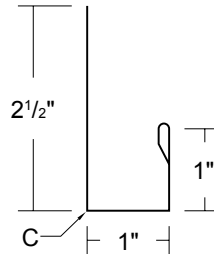

Length 10'-2"

## 1 1/4" BASE

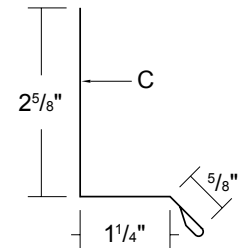

Length 10'-2"

## GRAVEL STOP

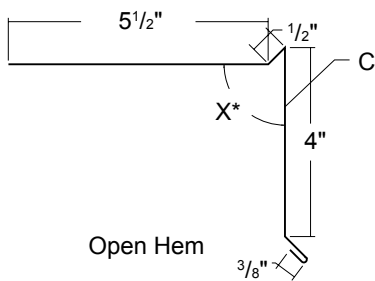

Length 10'-2" - \*Specify Slope Angle

## SCULPTURED HIGH SIDE EAVE

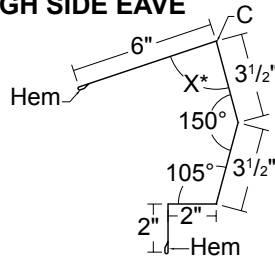

Lengths 10'-2" and 20'-3"  
\*Specify Slope Angle

## UNIVERSAL RIDGE COVER

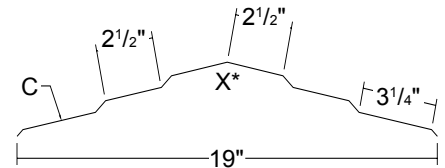

Length 10'-2" - \*Specify Slope Angle

C- Indicates color side of flashing.

**PRO-PANEL II CLOSURES**



Outside Closure



Inside Closure

Polyethylene Foam

**UNIVERSAL CLOSURE**

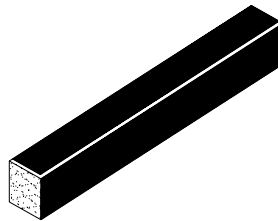

1" x 1 1/2" x 50' Polyethylene Foam  
1" x 1 1/2" x 10' Polyethylene Foam

**PRO-PANEL II LIGHT TRANSMITTING PANEL**

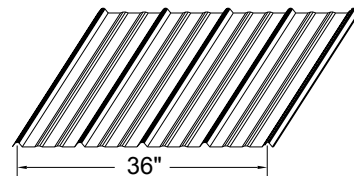

5 Ounce White Fiberglass  
Available In 10' and 12' Panels

**TUBE SEALANT**

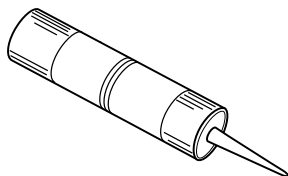

10.3 oz. Cartridge  
Urethane

**TAPE SEALANT**

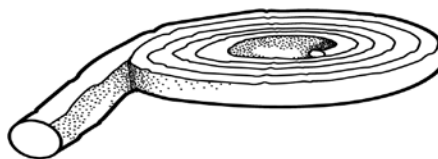

3/8" X 3/32" X 50'  
Single Bead Tape Sealant  
Butyl - Gray

**RUBBER ROOF JACK**

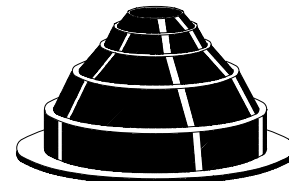

Mini (1/4" to 1 1/8" O.D. Pipe)  
#2 (1 3/4" to 3" O.D. Pipe)  
#4 (3" to 6" O.D. Pipe)  
#6 (6" to 9" O.D. Pipe)  
#8 (7" to 13" O.D. Pipe)

**RETRO ROOF JACK**

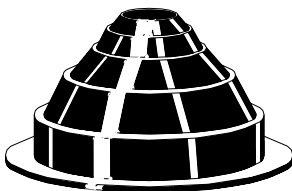

#801RETRO (3/4" to 2 3/4" O.D. Pipe)  
#802RETRO (2" to 7 1/4" O.D. Pipe)  
#803RETRO (3 1/4" to 10" O.D. Pipe)

**RUBBER ROOF FLASH KIT**

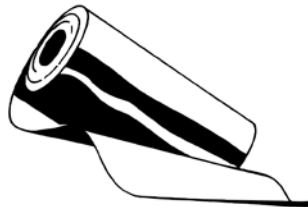

12" x 50'-0" Flash Kit  
18" x 50'-0" Flash Kit

**TOUCH-UP PAINT**

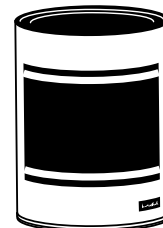

Available in 2 oz Bottles  
MS Colorfast45®

**CONTINUOUS RIDGE VENT**

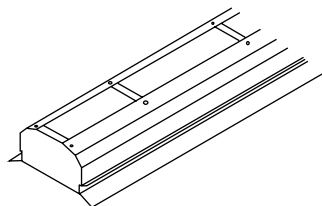

9" x 10', 12" x 10'

**PRO-PANEL II PANEL SHEAR**

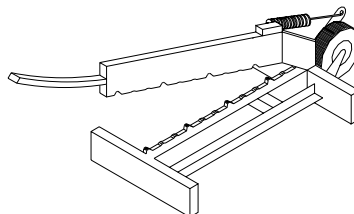

**VENT MATERIAL**

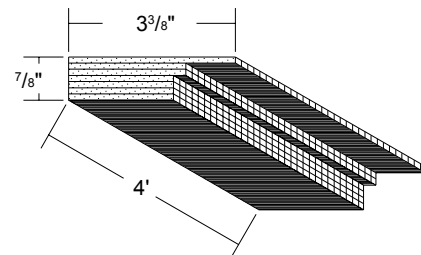

**LOUVRE WITH SCREEN**

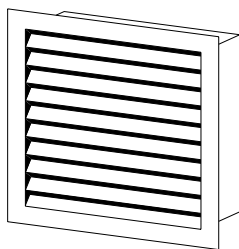

3' x 3' or 3' x 4'

# PRO-PANEL II® SECTION PROPERTIES AND LOAD TABLES

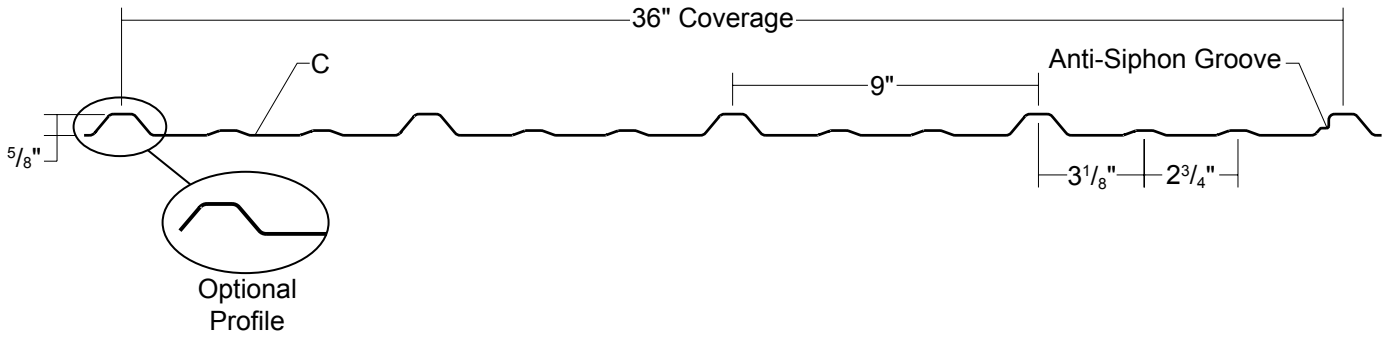

SECTION PROPERTIES								ALLOWABLE UNIFORM LOADS psf (3 or More Equal Spans)											
Ga	Width in	Yield ksi	Weight psf	Top in Compression		Bottom in Compression		Inward Load					Outward Load						
				Ixx in <sup>4</sup> /ft	Sxx in <sup>3</sup> /ft	Ixx in <sup>4</sup> /ft	Sxx in <sup>3</sup> /ft	2'	2.5'	3'	3.5'	4'	5'	2'	2.5'	3'	3.5'	4'	5'
29	36	80	0.63	0.0063	0.0126	0.0044	0.0129	87	57	40	28	19	10	85	55	39	28	19	10
26	36	80	0.80	0.0086	0.0175	0.0059	0.0168	114	74	52	36	24	12	118	76	53	36	24	12

- Theoretical section properties have been calculated per AISI 2012 "Specifications for the Design of Cold-formed Steel Structural Members." Ixx and Sxx are effective section properties for deflection and bending.
- Allowable load is calculated in accordance with AISI 2012 specifications considering bending, shear, combined bending and shear and deflection. Allowable load considers the 3 or more equal span condition. Allowable load does not address web crippling, fasteners/support connection or load testing. Panel weight is not considered.
- Deflection consideration is limited by a maximum deflection ratio of L/180 of span.
- Allowable loads do not include a 1/3 stress increase in uplift.
- Diaphragm Capacity** - 306 plf average Ultimate Shear Strength using the above fastening pattern on 2x supports located 2' on center per ASTM E 455-04.

## ATTACHMENT DETAIL

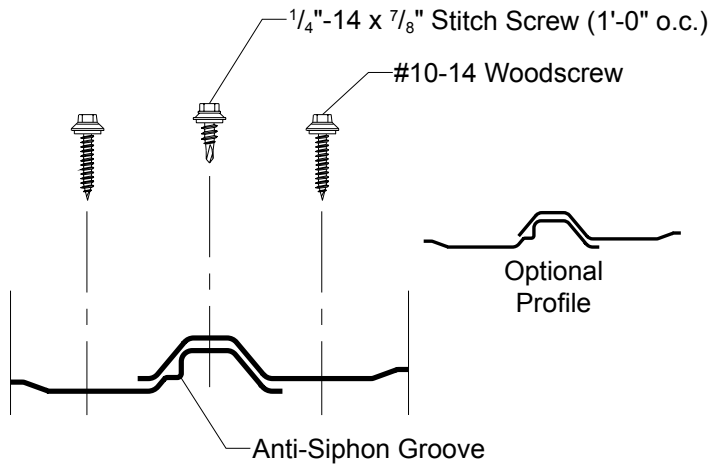

## FASTENING PATTERN

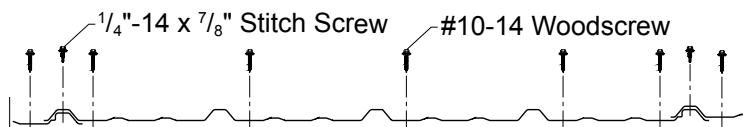

## GENERAL INFORMATION

### ► Slope

The minimum recommended slope for Pro-Panel II roof panel is 3:12.

### ► Substructure

Pro-Panel II is designed to be utilized over open structural framing, or a solid substrate. To avoid panel distortion, use a properly aligned and uniform substructure.

### ► Coverage

Pro-Panel II panels are available in a 5/8" rib height with a coverage width of 36".

### ► Length

Minimum factory cut length is 5'-0". Maximum recommended panel length is 45'-0". Longer panels require additional consideration in packaging, shipping, and erection. Please consult Metal Sales for recommendations.

### ► Fasteners

The fastener selection guide should be consulted for choosing the proper fastener for specific applications. Quantity and type of fastener must meet necessary loading and code requirements.

*NOTE: All panels are subject to surface distortion due to improperly applied fasteners. Overdriven fasteners will cause stress and induce oil canning across the face of the panel at or near the point of attachment.*

### ► Availability

Finishes: Acrylic Coated Galvalume® or MS Colorfast45®  
Gauges: 26 ga and 29 ga standard

## FASTENER INSTALLATION TECHNIQUE

**Recommended Tool Type** - Use depth locating nose or adjustable clutch on screw gun to prevent overdrilling and strip out. **Do not use impact tools or runners.**

**Seating the washer** - Apply sufficient torque to seat the washer - do not overdrive the fastener.

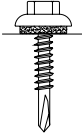
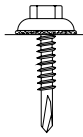
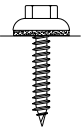
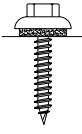
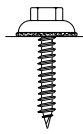
	<b>CORRECT</b> Sealing material slightly visible at edge of metal washer. Assembly is watertight.	<b>TOO LOOSE</b> Sealing material is not visible; not enough compression to seal properly.	<b>TOO TIGHT</b> Metal washer deformed; sealing material pressed beyond washer edge.
SELF DRILLER			
WOODSCREW			

**To prevent wobbling** - Make sure fastener head is completely engaged in the socket. If the head does not go all the way in the socket - tap the magnet deeper into the socket to allow full head engagement. Metal chips will build up from drilling and should be removed from time to time.

**Protect drill point** - Push only hard enough on the screw gun to engage clutch. This prevents excess friction and burn out of the drill point. Correct pressure will allow screw to drill and tap without binding.

**Drilling through sheet and insulation** - Ease up on pressure when drilling through insulation to avoid striking the purlin or girt with the point - apply more pressure after drill point contacts purlin or girt.

**Drilling through purlin overlaps** - Drilling through lapped purlins requires extra care. Excessive voids between purlins sometimes damages drill points and two self-drillers might be necessary to complete the operation. It is sometimes advantageous to predrill.

## CONDITION OF SUBSTRUCTURE

Whether over solid substrate or open structural framing, panel distortion may occur if not applied over properly aligned and uniform substructure.

The installer should check the roof deck for squareness before installing Pro-Panel II panels. Several methods can be used to verify squareness of the structure for proper installation of the panels.

**METHOD "A"** - One method for checking the roof for squareness is to measure diagonally across one slope of the roof from similar points at the ridge and eave and obtain the same dimension.

**METHOD "B"** - The 3-4-5 triangle system may also be used. To use this system measure a point from the corner along the edge of the roof at a module of three (3). Measure a point from the same corner along another edge at a module of four (4). Then by measuring diagonally between the two points established, the dimension should be exactly a module of five (5) to have a square corner. Multiple uses of this system may be required to determine building squareness. If the endwall cannot be made square, the roof system cannot be installed as shown in these instructions.

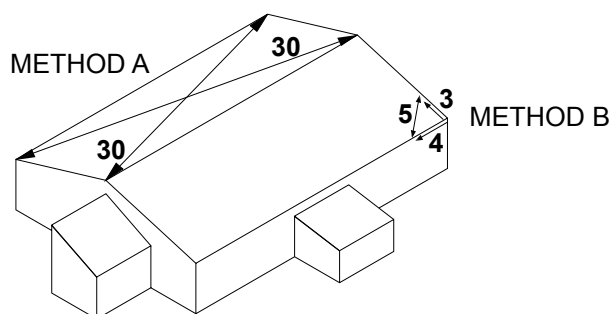

**PRO-PANEL II FASTENING PATTERNS**

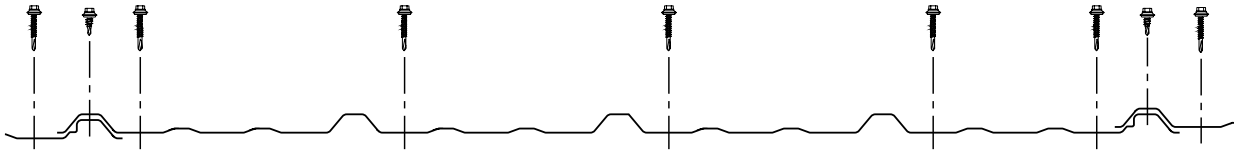
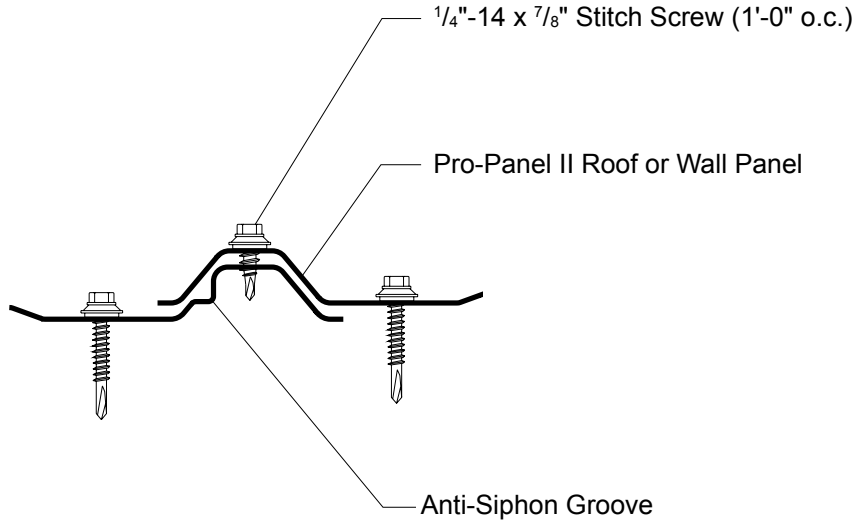

**Pro-Panel II Fastening Pattern - Interior**

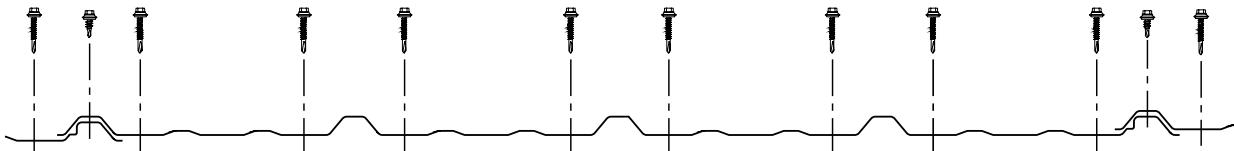

**Pro-Panel II Fastening Pattern - Ends**



# PRO-PANEL II® EAVE DETAIL

3:12 Minimum Roof Slope

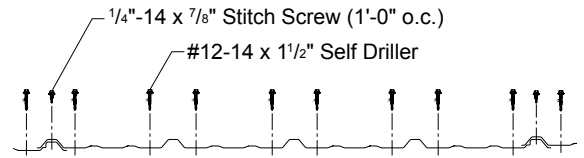
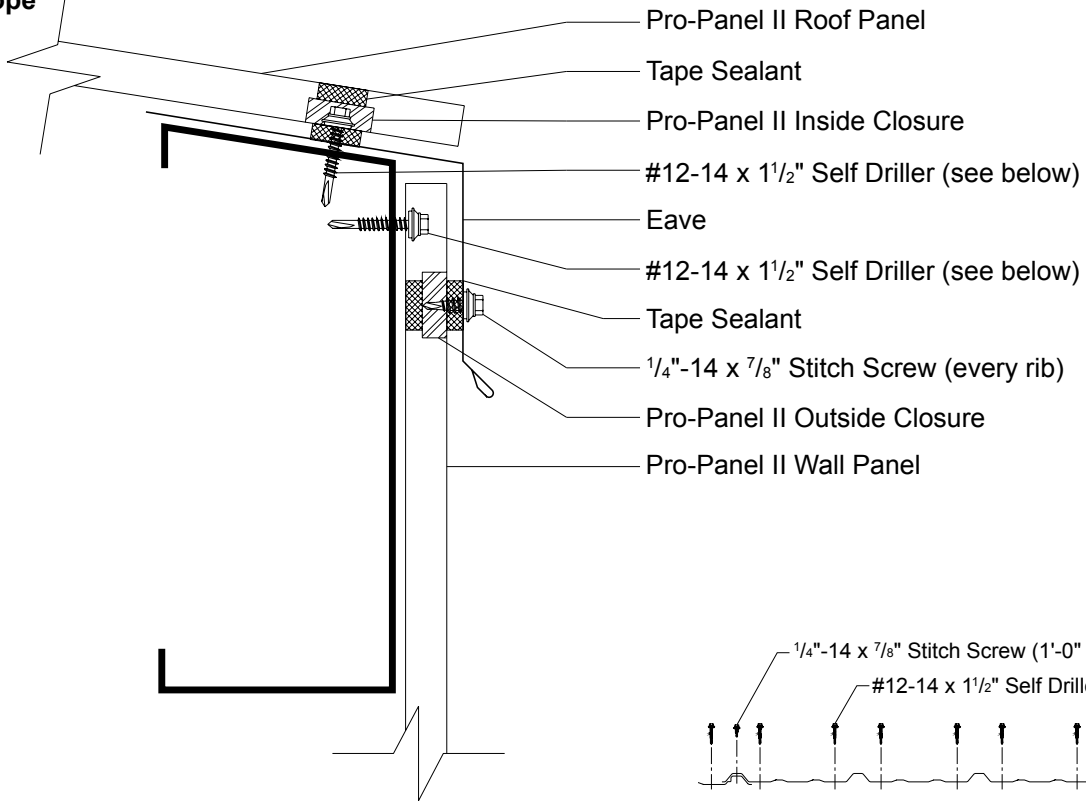

**Pro-Panel II Fastening Pattern**

# PRO-PANEL II BOX GUTTER DETAIL

3:12 Minimum Roof Slope

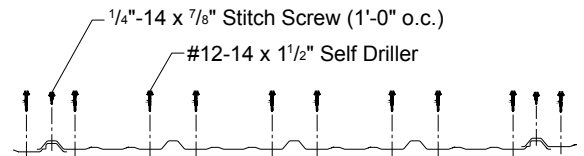
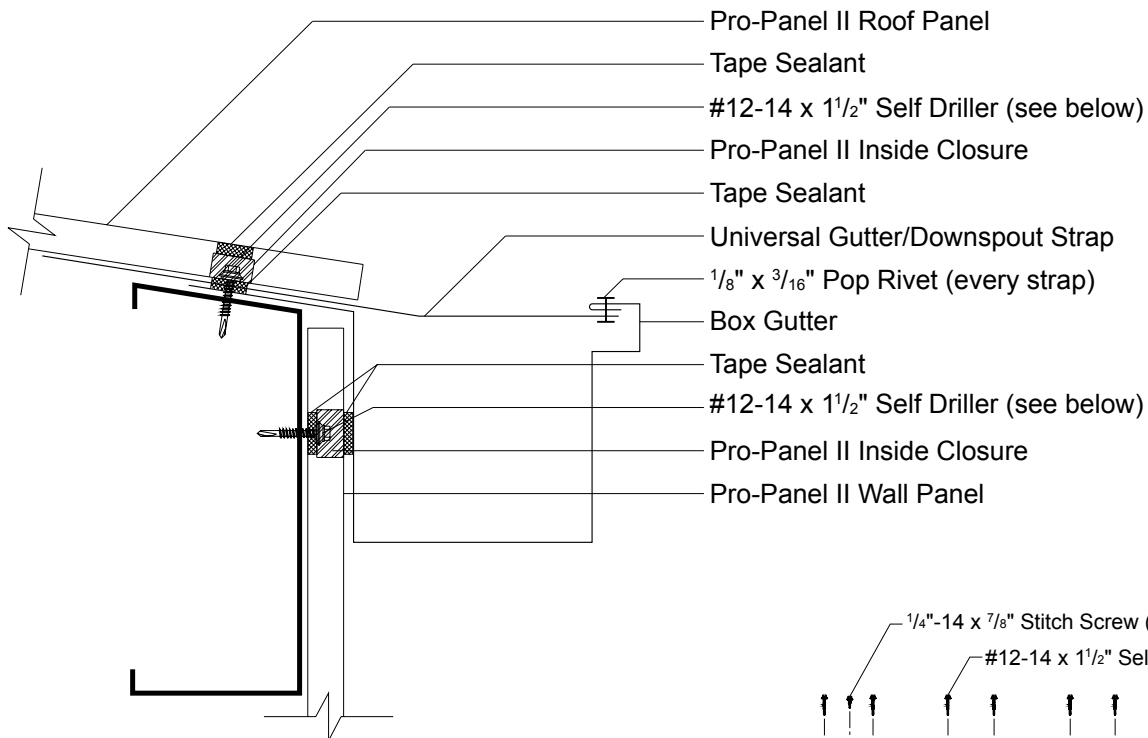

**Pro-Panel II Fastening Pattern**

# PRO-PANEL II® VALLEY DETAIL

3:12 Minimum  
Roof Slope

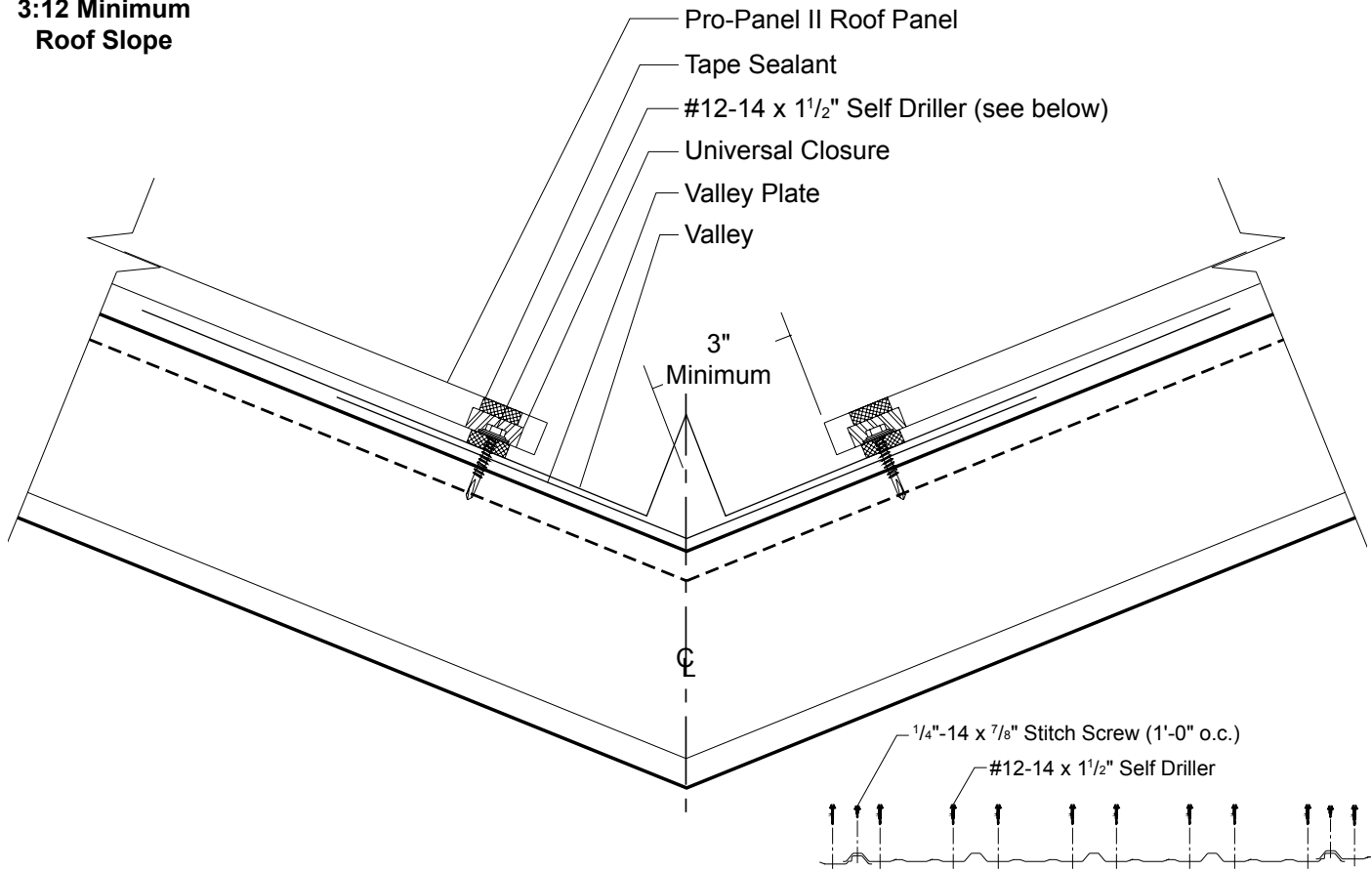

- Pro-Panel II Roof Panel
- Tape Sealant
- #12-14 x 1 1/2" Self Driller (see below)
- Universal Closure
- Valley Plate
- Valley

3"  
Minimum

- 1/4"-14 x 7/8" Stitch Screw (1'-0" o.c.)
- #12-14 x 1 1/2" Self Driller

**Pro-Panel II Fastening Pattern**

# PRO-PANEL II RAKE DETAIL

3:12 Minimum  
Roof Slope

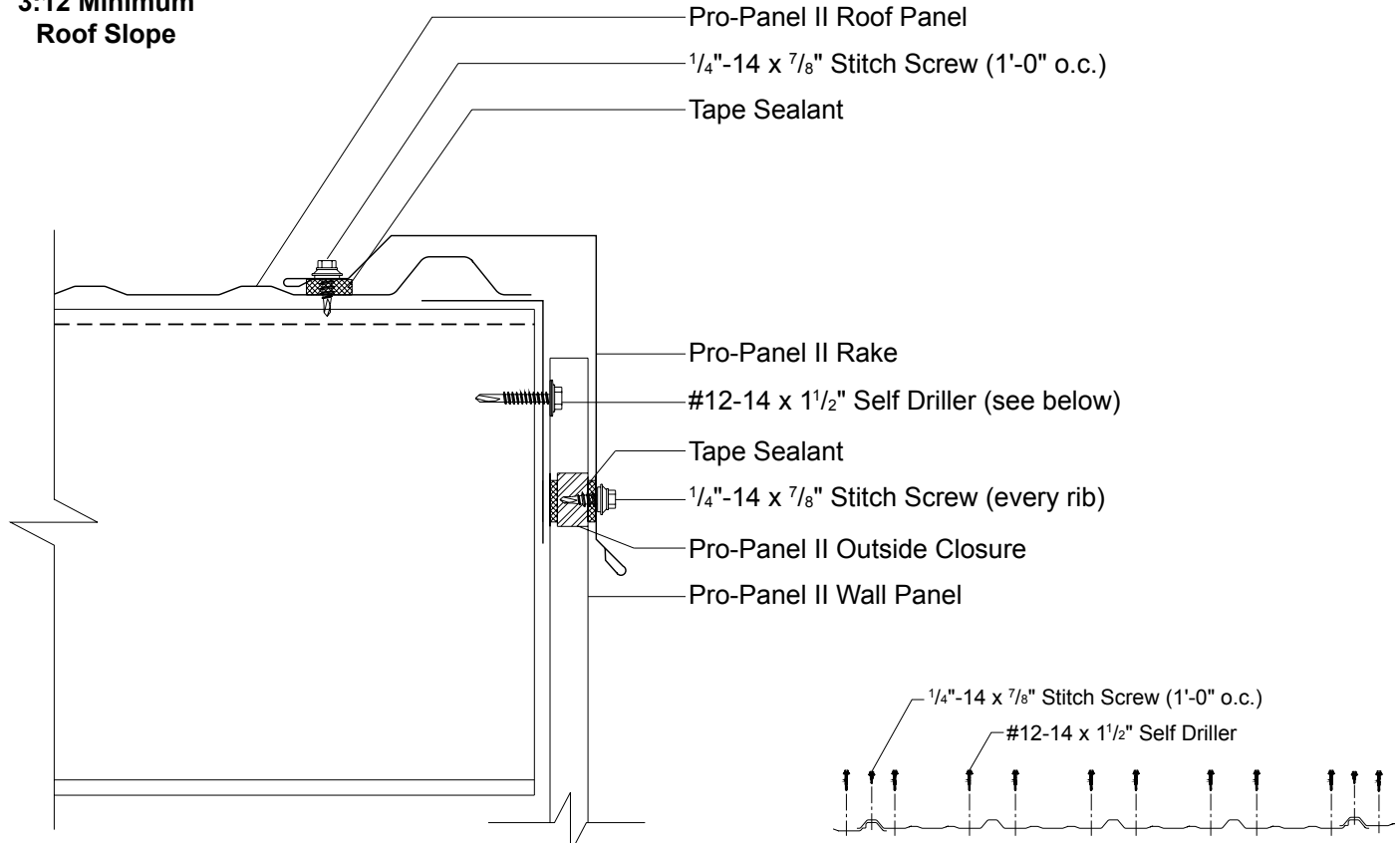

- Pro-Panel II Roof Panel
- 1/4"-14 x 7/8" Stitch Screw (1'-0" o.c.)
- Tape Sealant

- Pro-Panel II Rake
- #12-14 x 1 1/2" Self Driller (see below)
- Tape Sealant
- 1/4"-14 x 7/8" Stitch Screw (every rib)
- Pro-Panel II Outside Closure
- Pro-Panel II Wall Panel

- 1/4"-14 x 7/8" Stitch Screw (1'-0" o.c.)
- #12-14 x 1 1/2" Self Driller

**Pro-Panel II Fastening Pattern**

# PRO-PANEL II® RAKEWALL DETAIL

3:12 Minimum  
Roof Slope

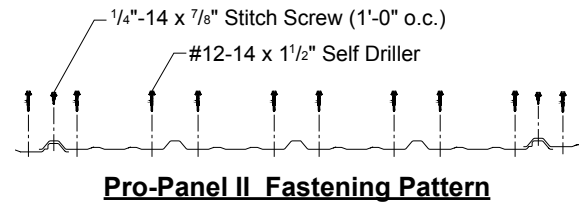
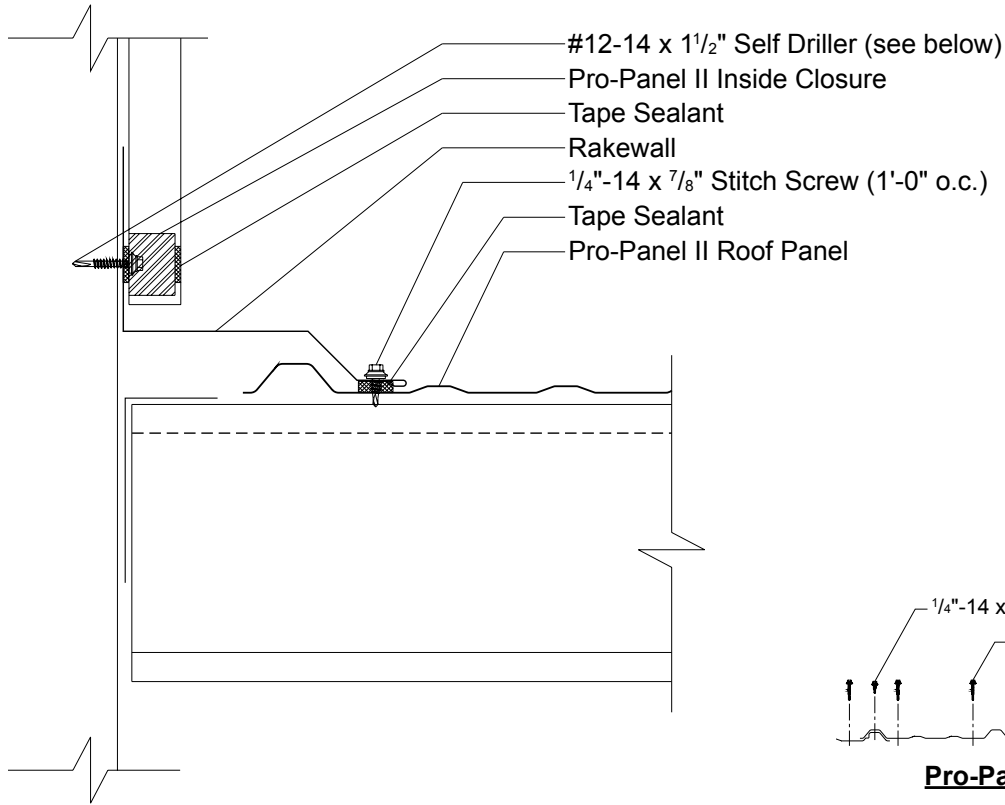

# PRO-PANEL II ENDWALL DETAIL

3:12 Minimum  
Roof Slope

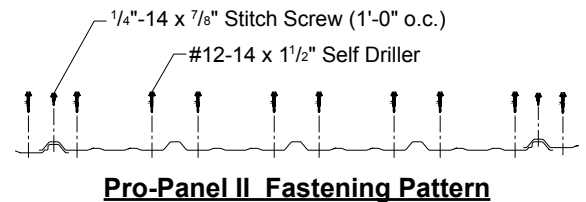
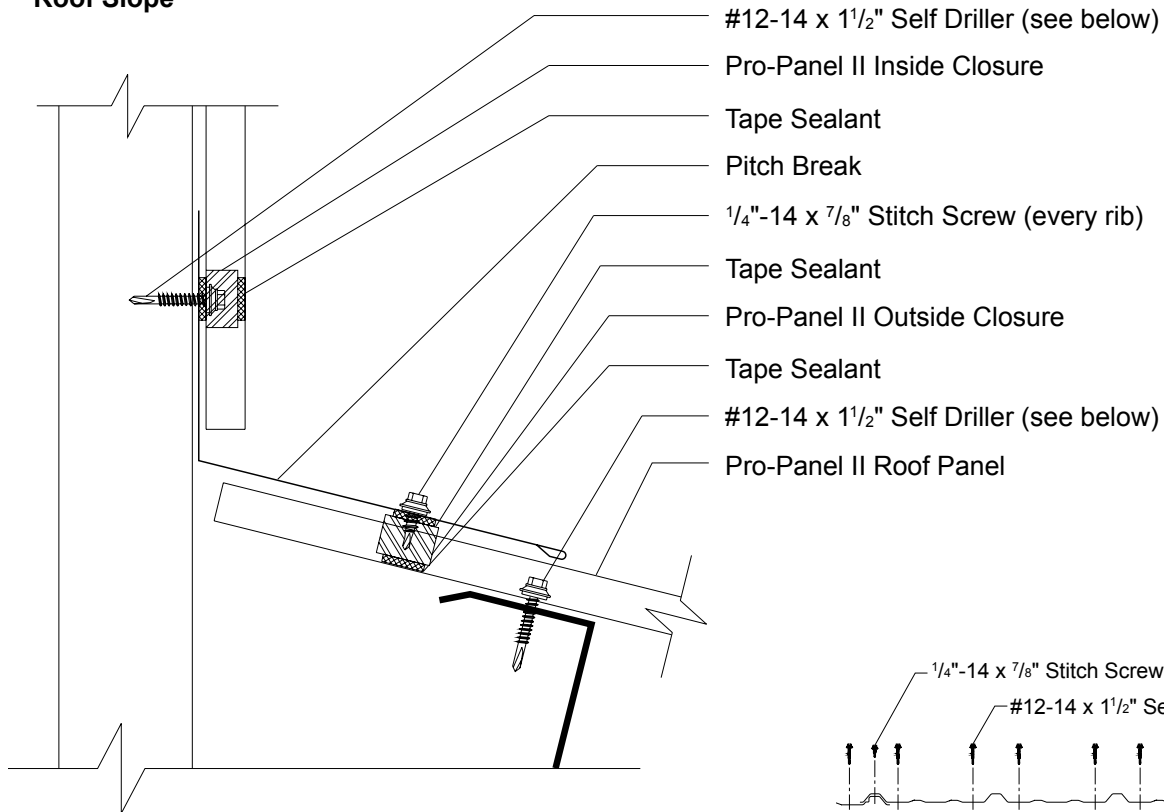

# PRO-PANEL II® SCULPTURED HIGH SIDE EAVE DETAIL

3:12 Minimum  
Roof Slope

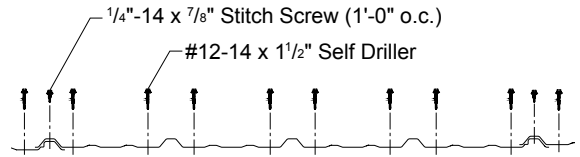
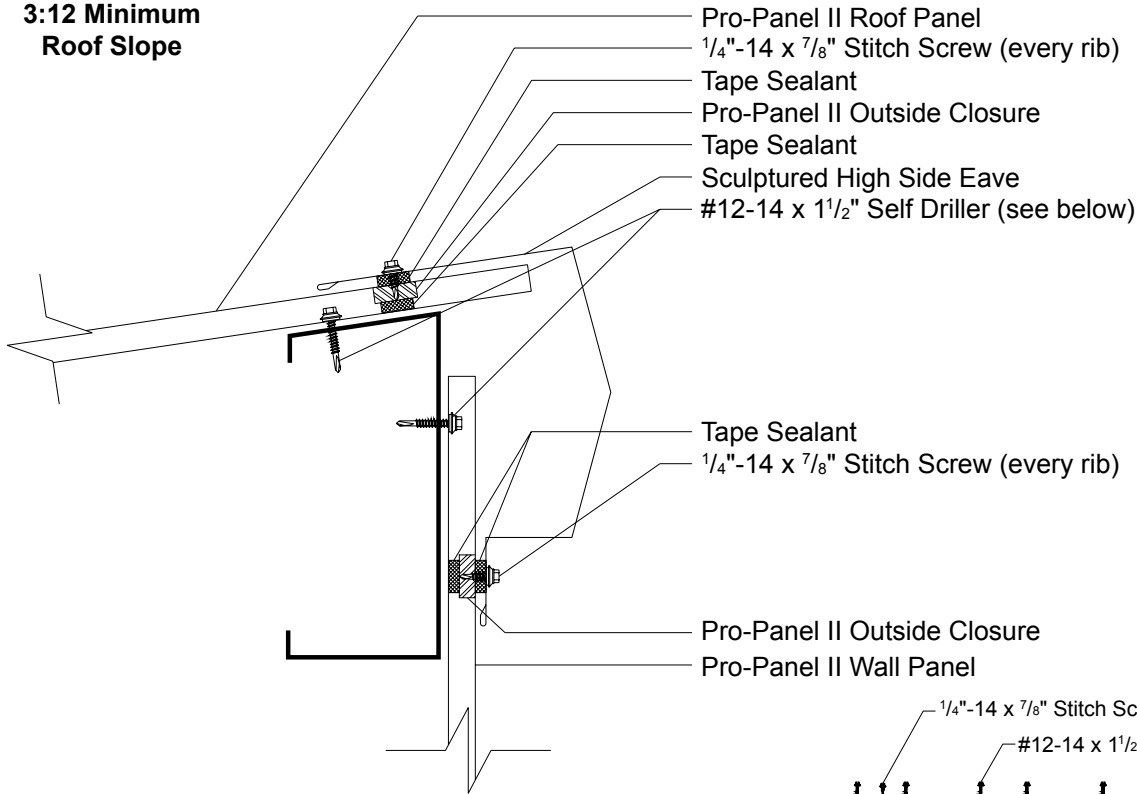

**Pro-Panel II Fastening Pattern**

# PRO-PANEL II 20" RIDGE/HIP DETAIL

3:12 Minimum  
Roof Slope

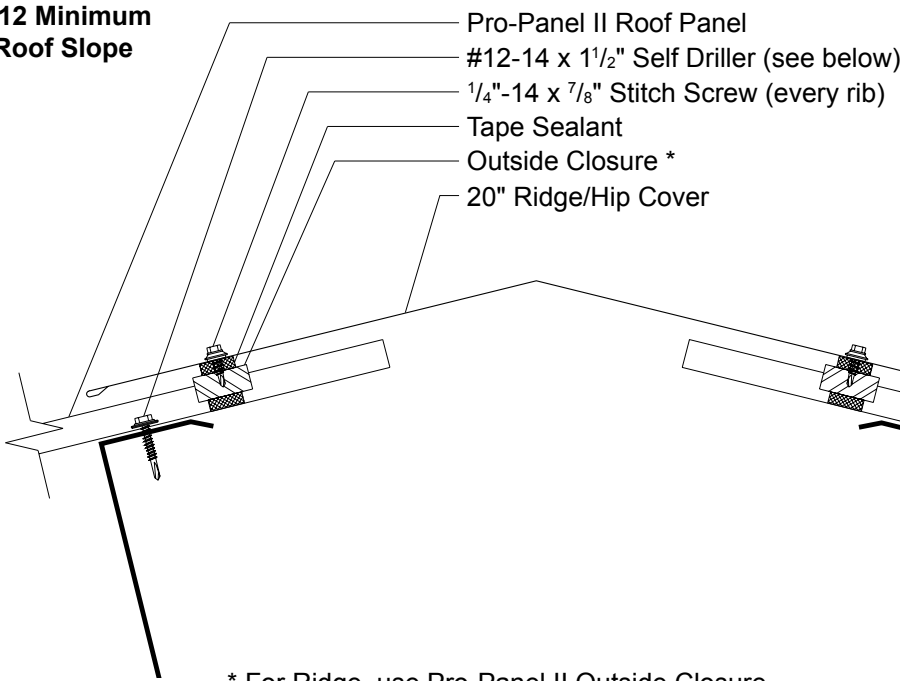

\* For Ridge, use Pro-Panel II Outside Closure.  
 For Hip, use Universal Closure.

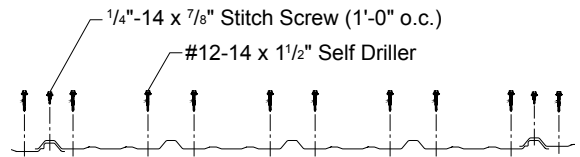

**Pro-Panel II Fastening Pattern**

# PRO-PANEL II® RIDGE DETAIL

3:12 Minimum  
Roof Slope

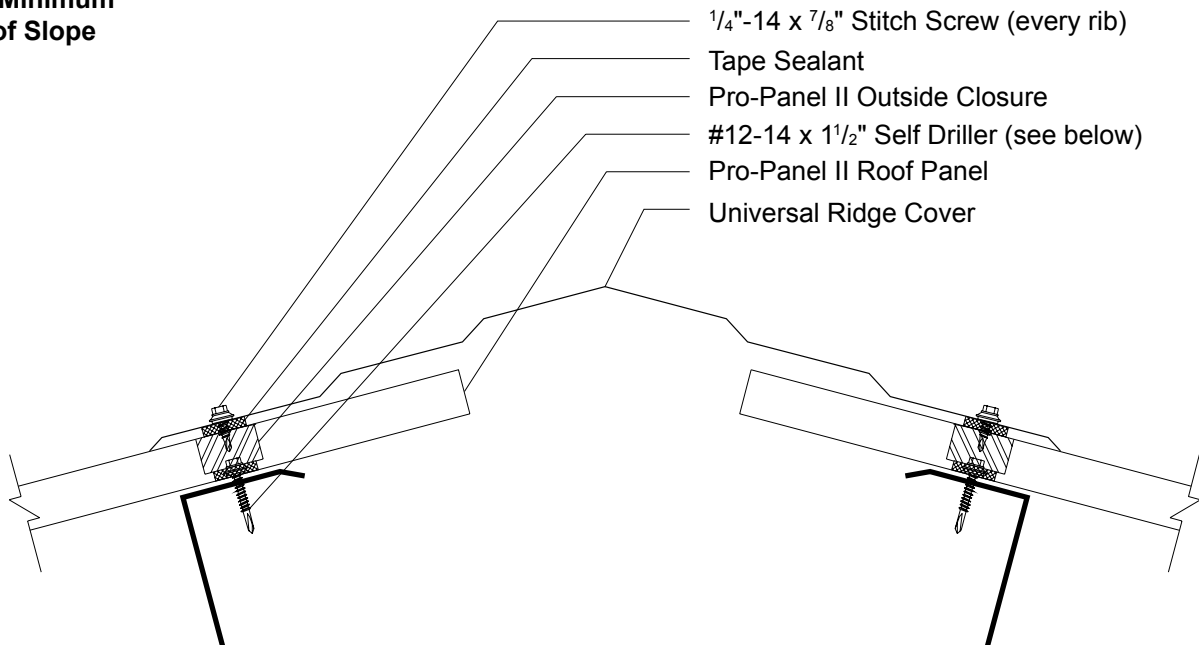

- 1/4"-14 x 7/8" Stitch Screw (every rib)
- Tape Sealant
- Pro-Panel II Outside Closure
- #12-14 x 1 1/2" Self Driller (see below)
- Pro-Panel II Roof Panel
- Universal Ridge Cover

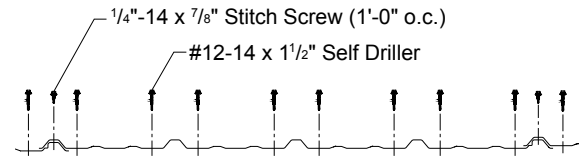

**Pro-Panel II Fastening Pattern**

# PRO-PANEL II GRAVEL STOP DETAIL

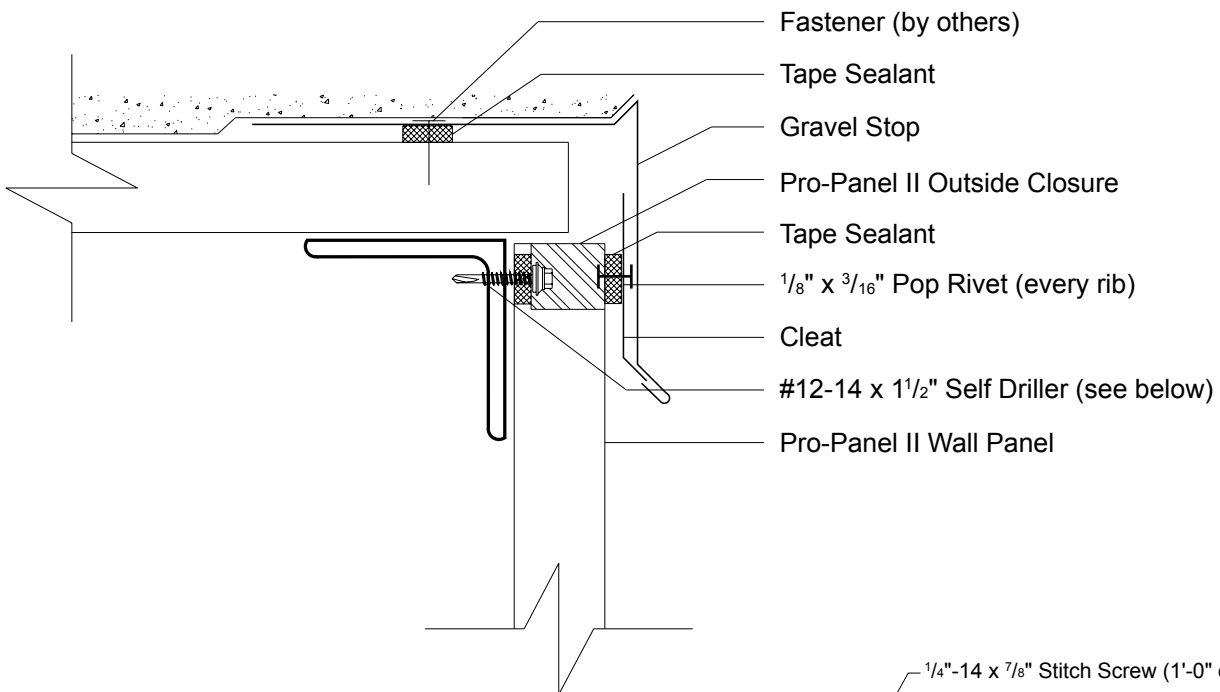

- Fastener (by others)
- Tape Sealant
- Gravel Stop
- Pro-Panel II Outside Closure
- Tape Sealant
- 1/8" x 3/16" Pop Rivet (every rib)
- Cleat
- #12-14 x 1 1/2" Self Driller (see below)
- Pro-Panel II Wall Panel

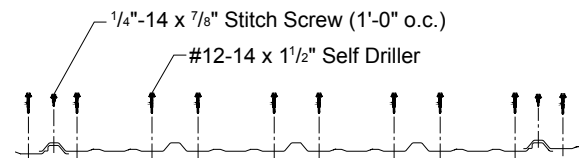

**Pro-Panel II Fastening Pattern**

# PRO-PANEL II® OUTSIDE CORNER DETAIL

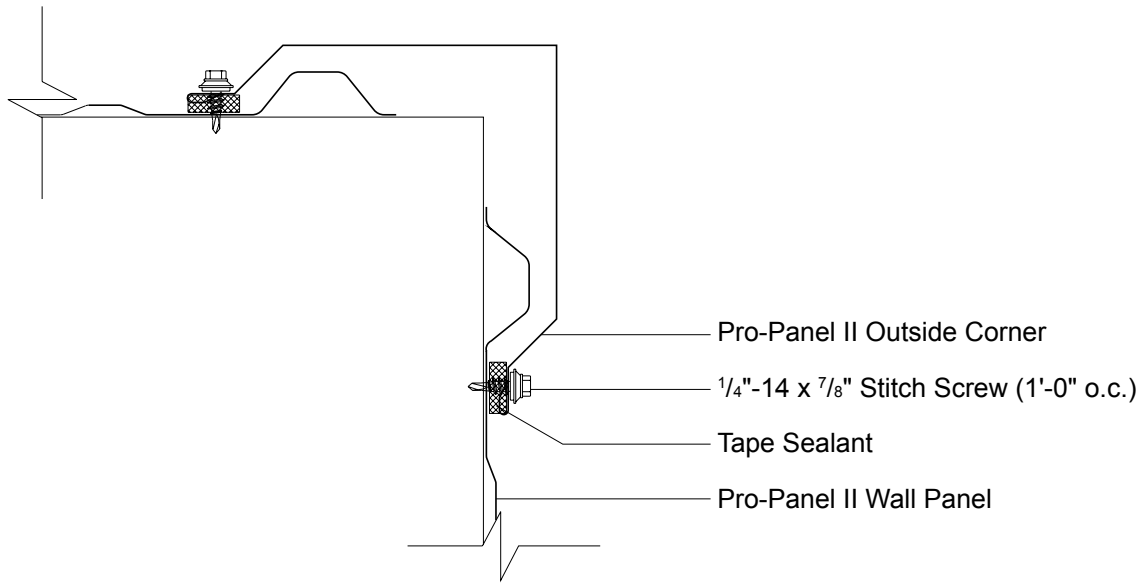

# PRO-PANEL II INSIDE CORNER DETAIL

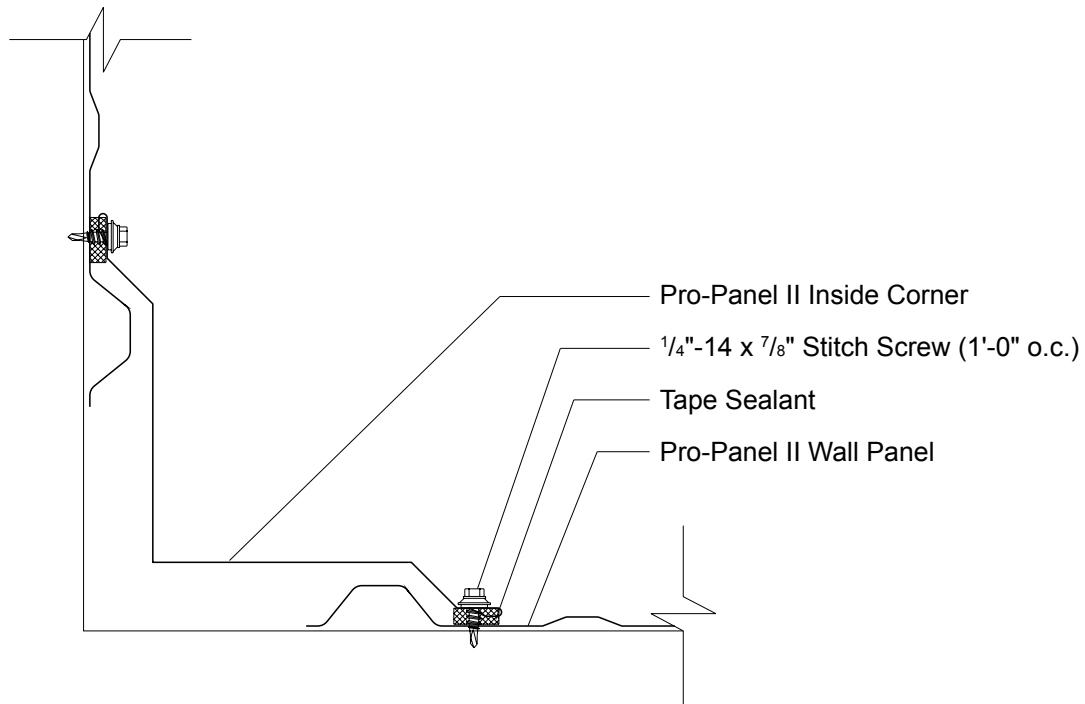

# PRO-PANEL II® JAMB DETAIL

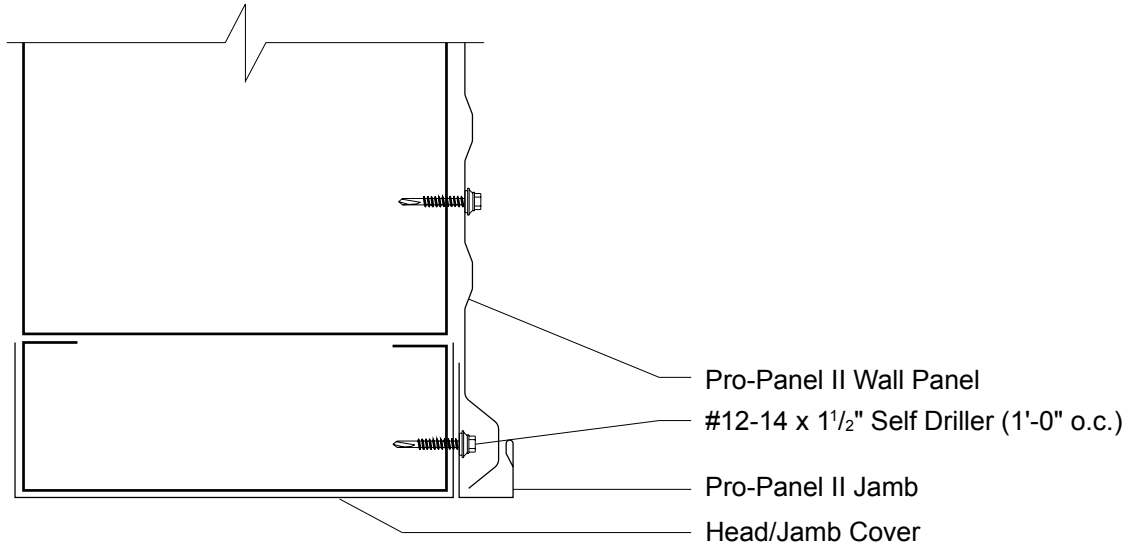

# PRO-PANEL II HEAD DETAIL

