

Product Page No.

Panel Information

Delta Rib Panel Profile PDR-2
 Panel Overview PDR-2

Flashing Profiles

Eave (Direct Fasten)..... PDR-3
 Sculptured Gutter PDR-3
 Sculptured Gutter End PDR-3
 Universal Gutter/Downspout Strap PDR-3
 6" x 4" Downspout PDR-3
 6" x 4" 95° Elbow PDR-3
 Downspout Bracket PDR-3
 Gutter Hanger PDR-3
 Sculptured Corner Box PDR-3
 Sculptured Peak Box PDR-3
 Valley PDR-3
 Sculptured Rake PDR-3
 Sculptured Rake End PDR-3
 Pitch Break PDR-3
 Sculptured High Side Eave..... PDR-3
 Counter Flashing PDR-4
 Reglet Flashing..... PDR-4
 20" Ridge/Hip Cover PDR-4
 Universal Ridge Cover..... PDR-4
 Vented Ridge Cover PDR-4
 Vent Drip..... PDR-4
 Gravel Stop..... PDR-4
 Inside Corner PDR-4
 Outside Corner PDR-4
 1.5" Sill/Head PDR-4
 1.5" Sill to Soffit PDR-4
 1.25" Base PDR-4
 Jamb PDR-4
 Head/Channel..... PDR-4
 Head Jamb Cover..... PDR-4
 Rake wall PDR-5
 Box Gutter PDR-5
 Box Gutter End PDR-5

Accessory Profiles

Delta Rib Closures..... PDR-5
 Universal Closure PDR-5
 Vent Material..... PDR-5
 Tube Sealant PDR-5
 Tape Sealant..... PDR-5
 Rubber Roof Jack..... PDR-5
 Retro Roof Jack..... PDR-5
 Rubber Roof Flashing Kit PDR-5
 Touch-Up Paint PDR-5
 Continuous Ridge Vent..... PDR-5
 Louver with Screen..... PDR-5

Testing Information

Section Properties and General Information PDR-6

Design/Installation Considerations

Fastener Installation Technique..... PDR-7
 Fastening Information..... PDR-8
 Condition of Substructure PDR-8

Product Page No.

Detail Conditions

Eave Detail PDR-9
 Box Gutter Detail PDR-9
 Valley Detail PDR-10
 Rake Detail PDR-10
 Rake wall with Counter Flashing Detail PDR-11
 Endwall with Counter Flashing Detail PDR-11
 Sculptured High Side Eave Detail PDR-12
 Ridge/Hip Detail..... PDR-12
 Universal Ridge Detail PDR-13
 Gravel Stop Detail PDR-13
 Outside Corner Detail PDR-14
 Inside Corner Detail..... PDR-14
 Jamb Detail..... PDR-15
 Head Detail..... PDR-15
 Base Detail PDR-16

Notes

Notes PDR-16

DELTA RIB PANEL OVERVIEW

DELTA RIB PROFILE

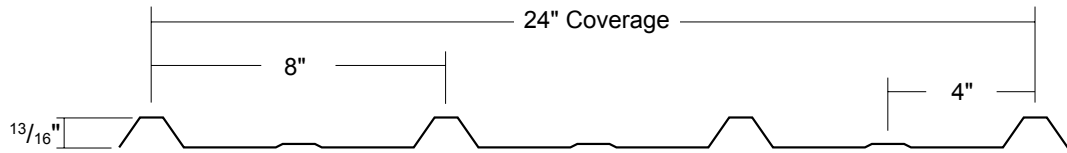

SLOPE

The minimum recommended slope for Delta Rib roof panels is 3:12. Metal Sales recommends that sidelap sealant be used in all roof applications.

SUBSTRATE

Delta Rib is designed to be utilized over open structural framing, but can easily be used with a solid substrate. The recommended substrate is 5/8" plywood with a 30 pound felt moisture barrier. To avoid panel distortion, use a properly aligned and uniform substructure.

COVERAGE

Delta Rib panel has a coverage of 24".

LENGTH

Lengths under 5'-0" are available with some cutting restrictions. Maximum recommended panel length is 45'-0". Longer panels require additional consideration in packaging, shipping, and erection. Please consult your Metal Sales branch for recommendations (see PGI-2 and PGI-3 for locations).

AVAILABILITY

Panels are available in 29 and 26 gauge.

APPLICATION

Residential, Agricultural, Commercial, Industrial and Architectural Panel

PERFORMANCE TEST

UL-2218, UL-790 and UL 263

FASTENING SYSTEM

Direct Fastened (exposed)

FASTENERS

The fastener selection guide should be consulted for choosing proper fasteners for specific applications. Quantity and type of fastener must meet necessary loading and code requirements (see PGI-12 through PGI-14).

MATERIALS

29 and 26 gauge steel: Grade 80 per ASTM A 792

FINISH

- ▶ *Acrylic Coated Galvalume® (ACG), AZ55 per ASTM A 792
- ▶ Prepainted Galvalume®, AZ50 per ASTM A 792
- ▶ MS Colorfast45®

* Differential appearance of Acrylic Coated Galvalume® roofing materials is not a cause for rejection.

EAVE (DIRECT FASTEN)

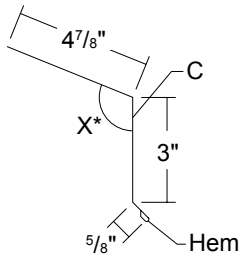

Length 10'-2" - *Specify Slope Angle

SCULPTURED GUTTER

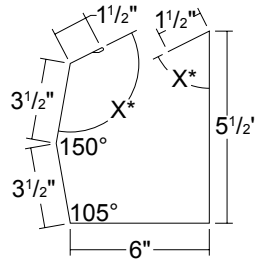

Lengths 10'-2" and 20'-3" *Specify Slope Angle

SCULPTURED GUTTER END

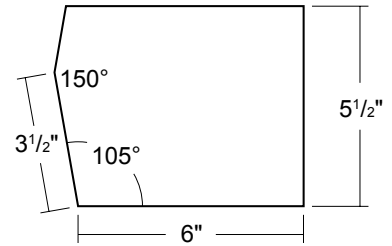

UNIVERSAL GUTTER/ DOWNSPOUT BRACKET

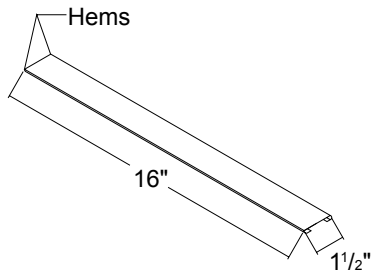

6" x 4" DOWNSPOUT

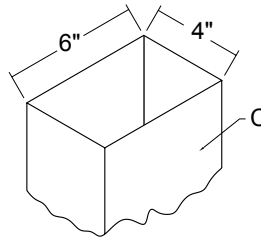

Lengths 10'-2" and 20'-3" (4" x 3 1/2" is also available)

6" x 4" 95° ELBOW

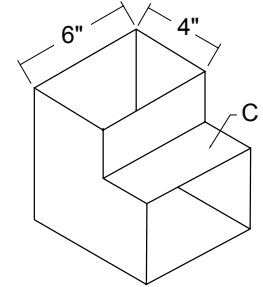

(4" x 3 1/2" is also available)

DOWNSPOUT BRACKET

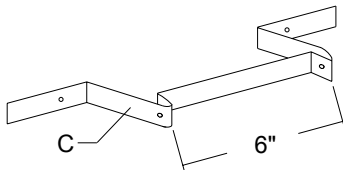

(4" is also available)

GUTTER HANGER

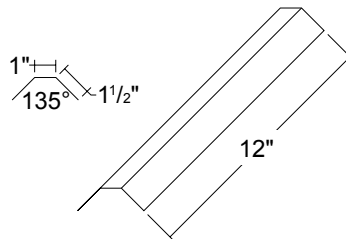

SCULPTURED CORNER BOX

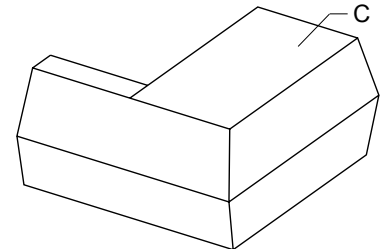

SCULPTURED PEAK BOX

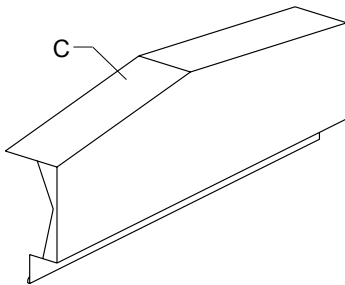

VALLEY

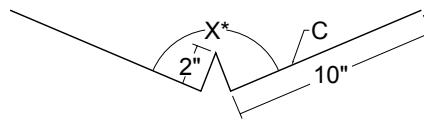

Lengths 10'-2" and 20'-3" *Specify Slope Angle

SCULPTURED RAKE

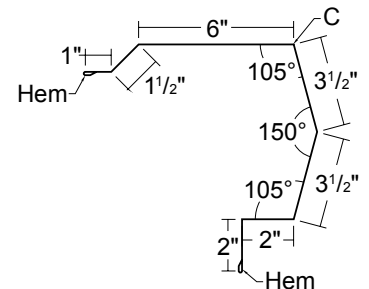

Lengths 10'-2" and 20'-3"

SCULPTURED RAKE END

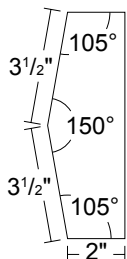

PITCH BREAK

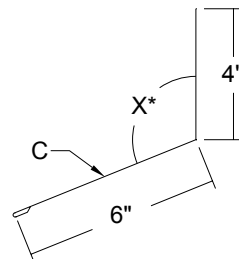

Length 10'-2" - *Specify Slope Angle

SCULPTURED HIGH SIDE EAVE

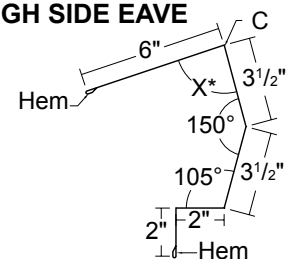

Lengths 10'-2" and 20'-3" *Specify Slope Angle

DELTA RIB FLASHING PROFILES (CONT.)

COUNTER FLASHING

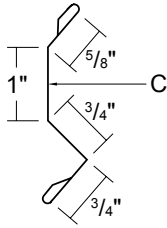

Length 10'-2"

REGLET FLASHING

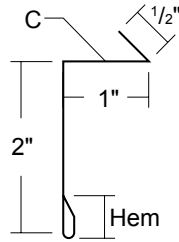

Length 10'-2"

20" RIDGE/HIP COVER

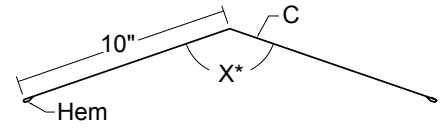

Lengths 10'-2" and 20'-3"
*Specify Slope Angle

UNIVERSAL RIDGE COVER

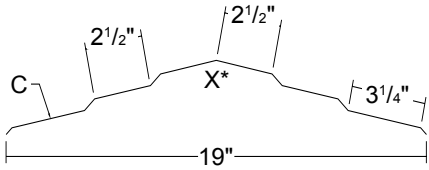

Length 10'-2" - *Specify Slope Angle

VENTED RIDGE COVER

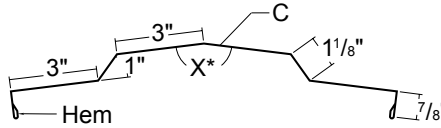

Lengths 10'-2" and 20'-3"
*Specify Slope Angle

VENT DRIP

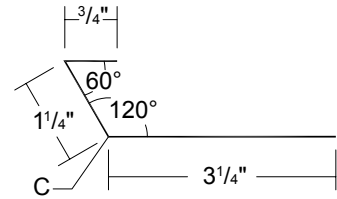

Length 10'-2"

GRAVEL STOP

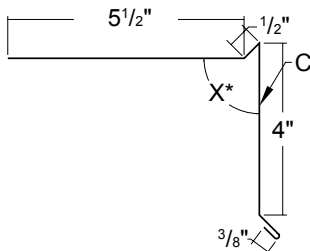

Lengths 10'-2" and 20'-3"
*Specify Slope Angle

INSIDE CORNER

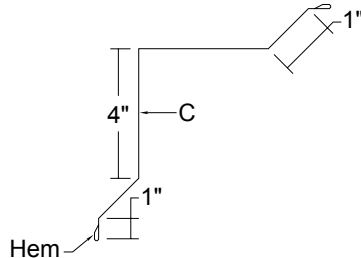

Lengths 10'-2", 14'-2" and 20'-3"

OUTSIDE CORNER CORNER

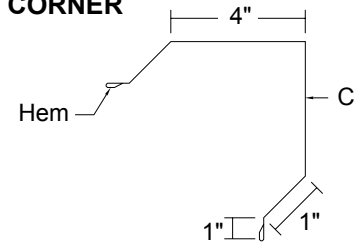

Lengths 10'-2", 14'-2" and 20'-3"

1.5" SILL/HEAD

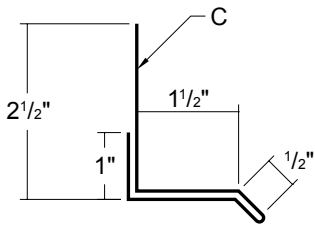

Length 10'-2"

1.5" SILL TO SOFFIT

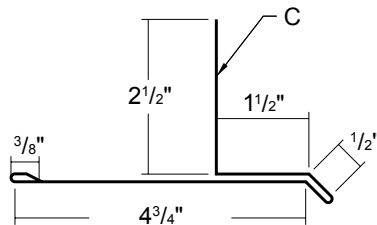

Length 10'-2"

1 1/4" BASE

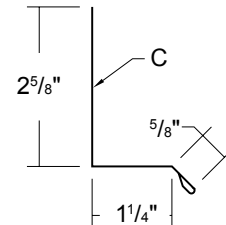

Length 10'-2"

JAMB

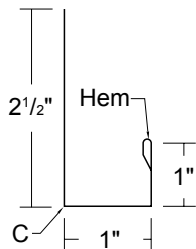

Lengths 7'-3", 10'-2" and 14'-2"

HEAD CHANNEL

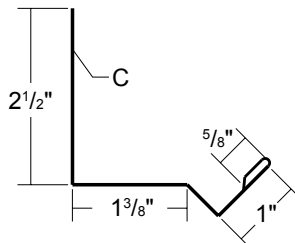

Length 10'-2"

HEAD/JAMB COVER

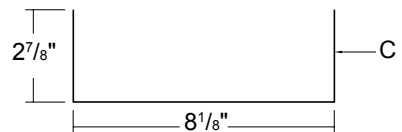

Lengths 10'-2" and 14'-2"

DELTA RIB FLASHING PROFILES (CONT.) / ACCESSORY PROFILES

RAKEWALL

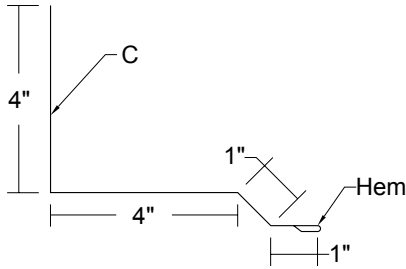

Length 10'-2"

BOX GUTTER

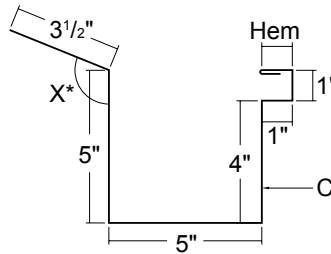

Length 10'-2" and 20'-3"
*Specify Slope Angle

BOX GUTTER END

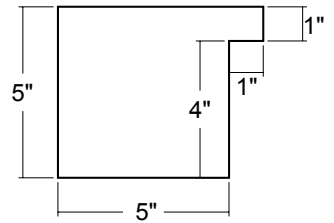

DELTA-RIB ACCESSORY PROFILES

C- Indicates color side of flashing.

DELTA RIB CLOSURES

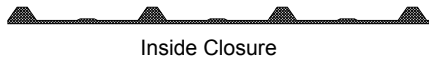

Inside Closure



Outside Closure

Polyethylene Foam

UNIVERSAL CLOSURE

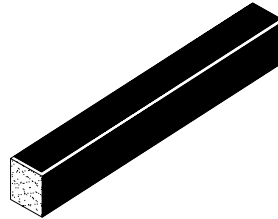

1" x 1 1/2" x 50' Polyethylene Foam
1" x 1 1/2" x 10' Polyethylene Foam

VENT MATERIAL

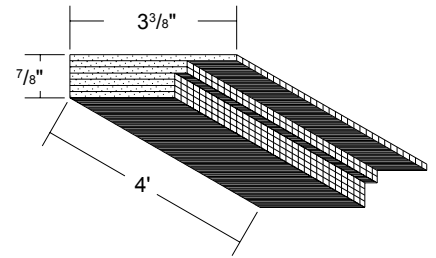

TUBE SEALANT

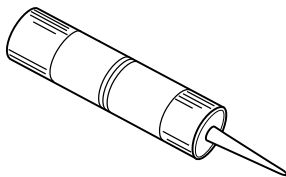

10.3 oz. Cartridge
Urethane

TAPE SEALANT

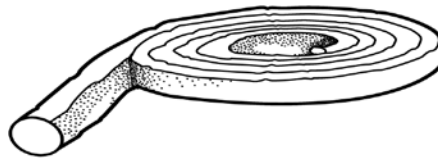

3/8" X 3/32" X 50'
Single Bead Tape Sealant
Butyl - Gray

RUBBER ROOF JACK

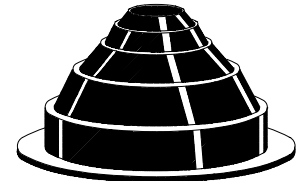

Mini (1/4" to 1/8" O.D. Pipe)
#2 (1 3/4" to 3" O.D. Pipe)
#4 (3" to 6" O.D. Pipe)
#6 (6" to 9" O.D. Pipe)
#8 (7" to 13" O.D. Pipe)

RETRO ROOF JACK

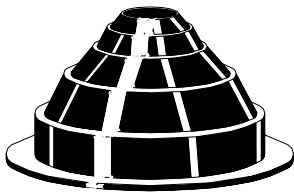

#801_{RETRO} (3/4" to 2 3/4" O.D. Pipe)
#802_{RETRO} (2" to 7 1/4" O.D. Pipe)
#803_{RETRO} (3 1/4" to 10" O.D. Pipe)

RUBBER ROOF FLASH KIT

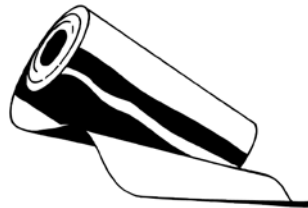

12" x 50'-0" Flash Kit
18" x 50'-0" Flash Kit

TOUCH-UP PAINT

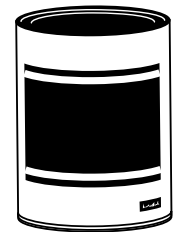

Available in 2 oz Bottles
PVDF / MS Colorfast45®

CONTINUOUS RIDGE VENT

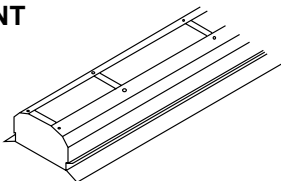

9" x 10' or 12" x 10'

LOUVER WITH SCREEN

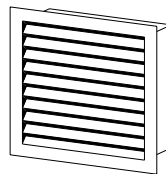

3' x 3' or 3' x 4'

DELTA RIB SECTION PROPERTIES AND LOAD TABLES

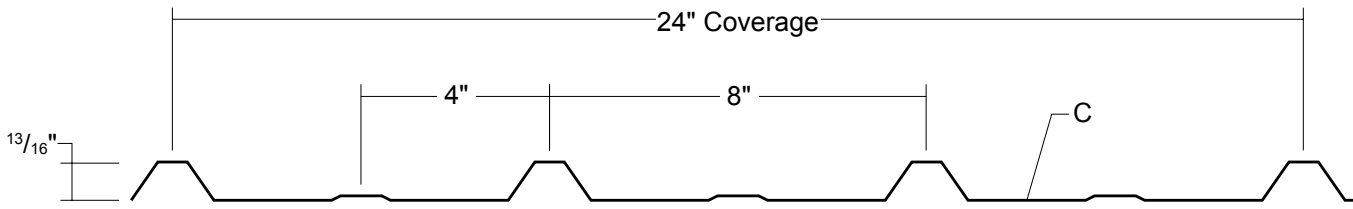

SECTION PROPERTIES								ALLOWABLE UNIFORM LIVE LOADS psf (3 or More Equal Spans)											
Ga	Width in	Yield ksi	Weight psf	Top in Compression		Bottom in Compression		Inward Load					Outward Load						
				I _{xx} in ⁴ /ft	S _{xx} in ³ /ft	I _{xx} in ⁴ /ft	S _{xx} in ³ /ft	2'	2.5'	3'	3.5'	4'	5'	2'	2.5'	3'	3.5'	4'	5'
29	24	80	0.64	0.0116	0.0193	0.0101	0.0228	141	94	67	50	37	19	124	82	58	43	33	19
26	24	80	0.82	0.0165	0.0283	0.0136	0.0295	194	127	89	66	48	24	187	122	86	64	48	24

- Theoretical section properties have been calculated per AISI 2012 "Specifications for the Design of Cold-formed Steel Structural Members". I_{xx} and S_{xx} are effective section properties for deflection and bending.
- Allowable load is calculated in accordance with AISI 2012 specifications considering bending, shear, combined bending and shear and deflection. Allowable load considers the 3 or more equal span condition. Allowable load does not address web crippling, fasteners/support connection or load testing. Panel weight is not considered.
- Deflection consideration is limited by a maximum deflection ratio of L/180 of span.
- Allowable loads do not include a 1/3 stress increase in uplift.

ATTACHMENT DETAIL

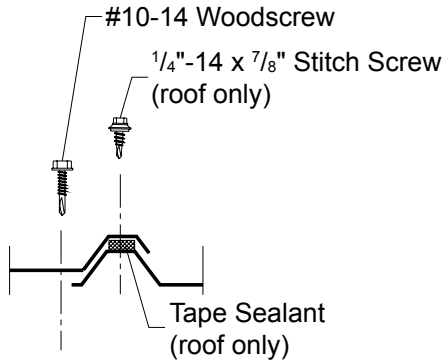

FASTENING PATTERN

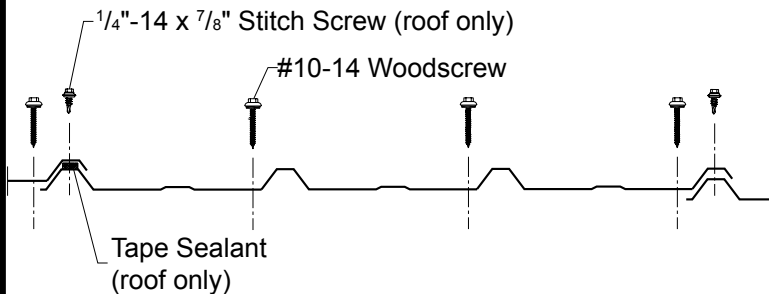

GENERAL INFORMATION

► Slope

The minimum recommended slope for Delta Rib roofing panel is 3:12. Metal Sales recommends that in all roof applications, sealants and stitch screws be used on all sidelaps.

► Substructure

Delta Rib is designed to be utilized over open structural framing, but can easily be used with a solid substrate. To avoid panel distortion, use a properly aligned and uniform substructure.

► Coverage

Delta Rib panels are available in a ¹³/₁₆" rib height with a coverage width of 24".

► Length

Minimum factory cut length is 5'-0". Maximum recommended panel length is 40'-0". Longer panels require additional consideration in packaging, shipping, and erection. Please consult Metal Sales for recommendations.

► Fasteners

The fastener selection guide should be consulted for choosing the proper fastener for specific applications. Quantity and type of fastener must meet necessary loading and code requirements.

NOTE: All panels are subject to surface distortion due to improperly installed fasteners. Over-driven fasteners will cause stress and induce oil canning across the face of the panel at or near the point of attachment.

► Availability

Finishes: MS Colorfast45® and Acrylic Coated Galvalume®
Gauge: 29 and 26 ga

FASTENER INSTALLATION TECHNIQUE

USING NAILS:

If nails are used as a fastening method, it is best to use a painted or galvanized steel ring shank nail with a flat neoprene washer. Nails should penetrate the wood support to a depth of at least 1/4", but should not be too long as to protrude completely through the support. Nails must not be driven to tight. Overdriving may cause damage to washers and/or the steel sheet. Nails should be driven perpendicular to the wood support, unless the manufacturer's directs otherwise. Typically 1lb of nails should be used per square for 2' wide panels and 2 lbs of nails should be used per square for 3' wide panels.

USING SCREWS:

If screws are used as a fastening method, it is best to use a painted or plated screw, Type A or driller tip with a flat rubber washer. The correct screw gun is also important to the proper installation of self-drilling or self-tapping screws. A tool with the appropriate speed and torque setting (as recommended by the fastener manufacturer) will help prevent fastener thread strip-out and possible damage to the panel or its coating. Typically 40 screws should be used per square for 2' wide panels and 80 screws should be used per square for 3' wide panels.

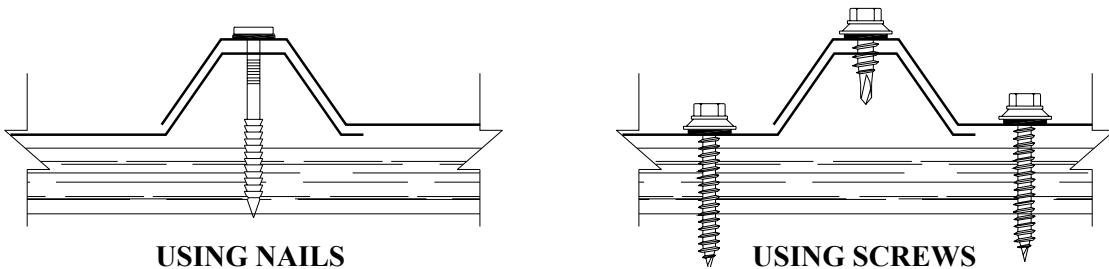

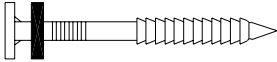
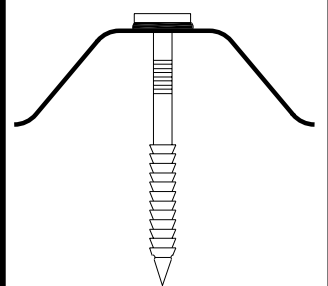
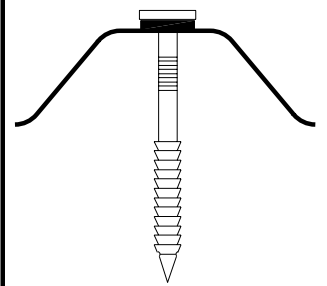
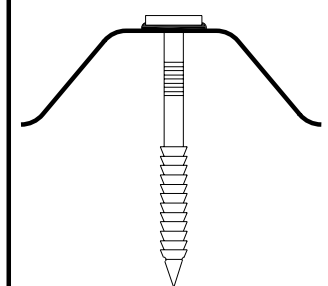
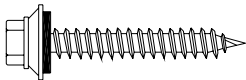
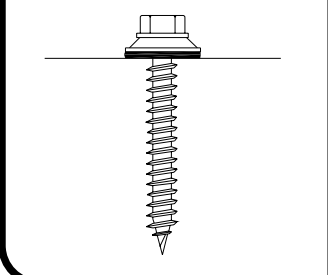
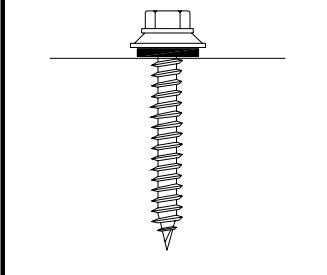
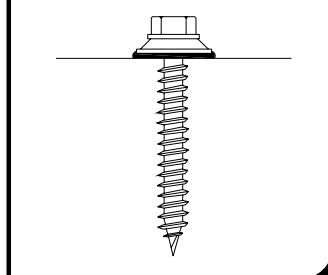
	CORRECT Sealing material slightly visible at edge of washer. Assembly is water tight.	TOO LOOSE Sealing material is not visible; not enough compression to seal.	TOO TIGHT Washer is deformed; sealing material pressed beyond fastener edge.
			
			

SEATING THE WASHER - Apply sufficient torque to seat the washer - do not overdrive the fastener.

TO PREVENT WOBBLING - Make sure fastener head is completely engaged in the socket. If the head does not go all the way in the socket - tap the magnet deeper into the socket to allow full head engagement. Metal chips will build up from drilling and should be removed from time to time.

PROTECT DRILL POINT - Push only hard enough on the screw gun to engage clutch. This prevents excess friction and burn out of the drill point. Correct pressure will allow screw to drill and tap without binding.

FASTENING PATTERN

Note: Fastening patterns should be checked to meet applicable loading conditions.

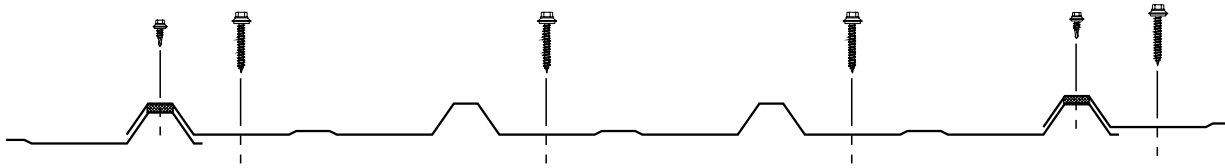
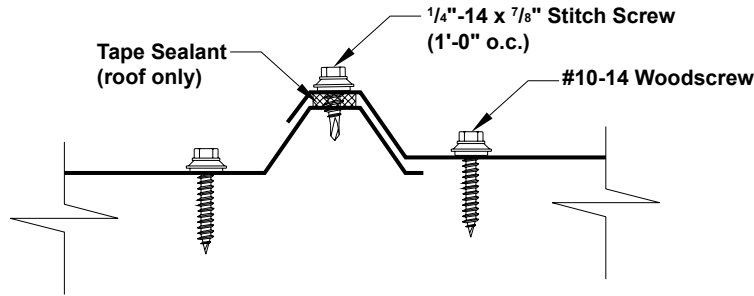

Typical Screw Fastening Pattern



Typical Nail Fastening Pattern

CONDITION OF SUBSTRUCTURE

Whether over solid substrate or open structural framing, panel distortion may occur if not applied over properly aligned and uniform substructure.

The installer should check the roof deck for squareness before installing Delta Rib Panels. Several methods can be used to verify squareness of the structure for proper installation of the panels.

METHOD "A" - One method for checking the roof for squareness is to measure diagonally across one slope of the roof from similar points at the ridge and eave and obtain the same dimension.

METHOD "B" - The 3-4-5 triangle system may also be used. To use this system measure a point from the corner along the edge of the roof at a module of three (3). Measure a point from the same corner along another edge at a module of four (4). Then by measuring diagonally between the two points established, the dimension should be exactly a module of five (5) to have a square corner. Multiple uses of this system may be required to determine building squareness. If the endwall cannot be made square, the roof system cannot be installed as shown in these instructions.

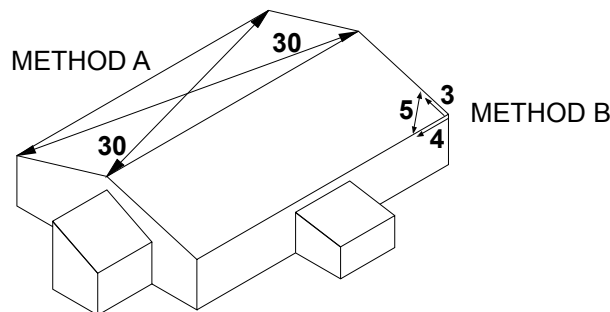

DELTA RIB EAVE DETAIL

3:12 Minimum Roof Slope

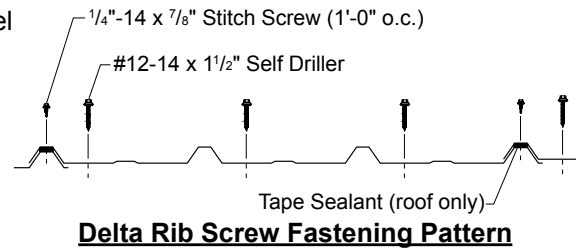
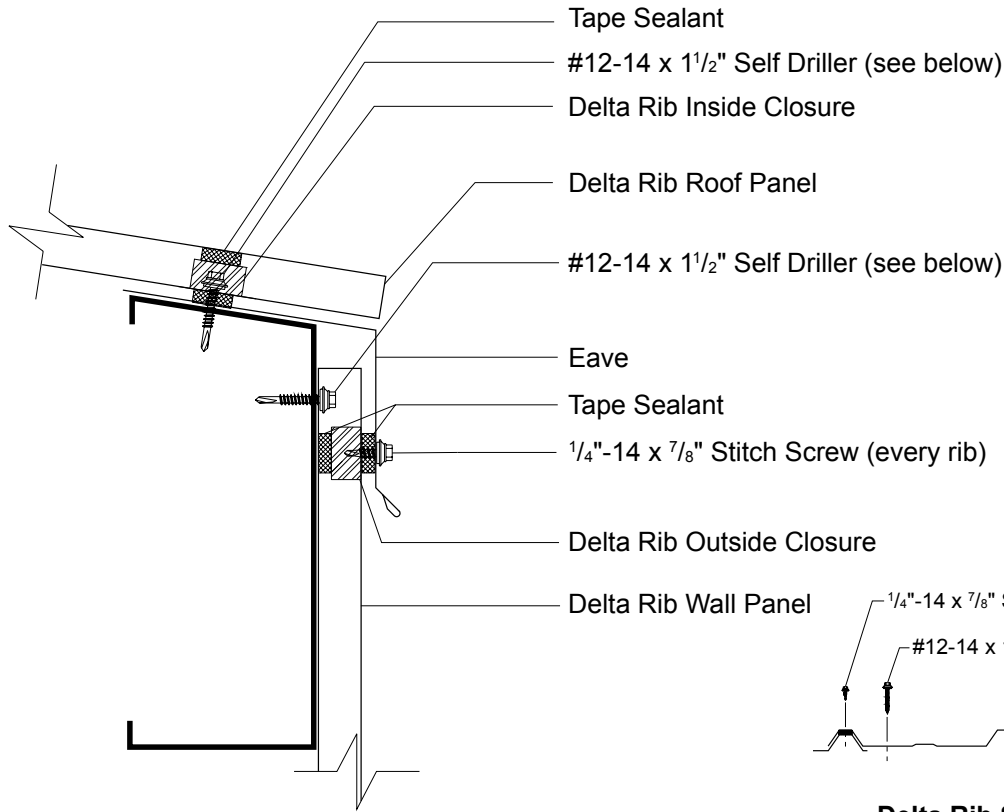

DELTA-RIB GUTTER DETAIL

3:12 Minimum Roof Slope

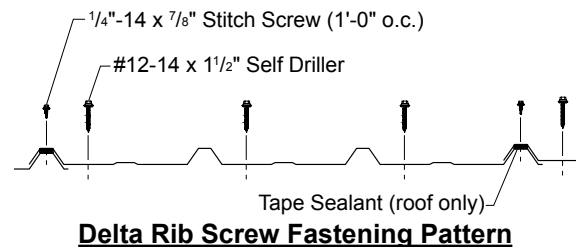
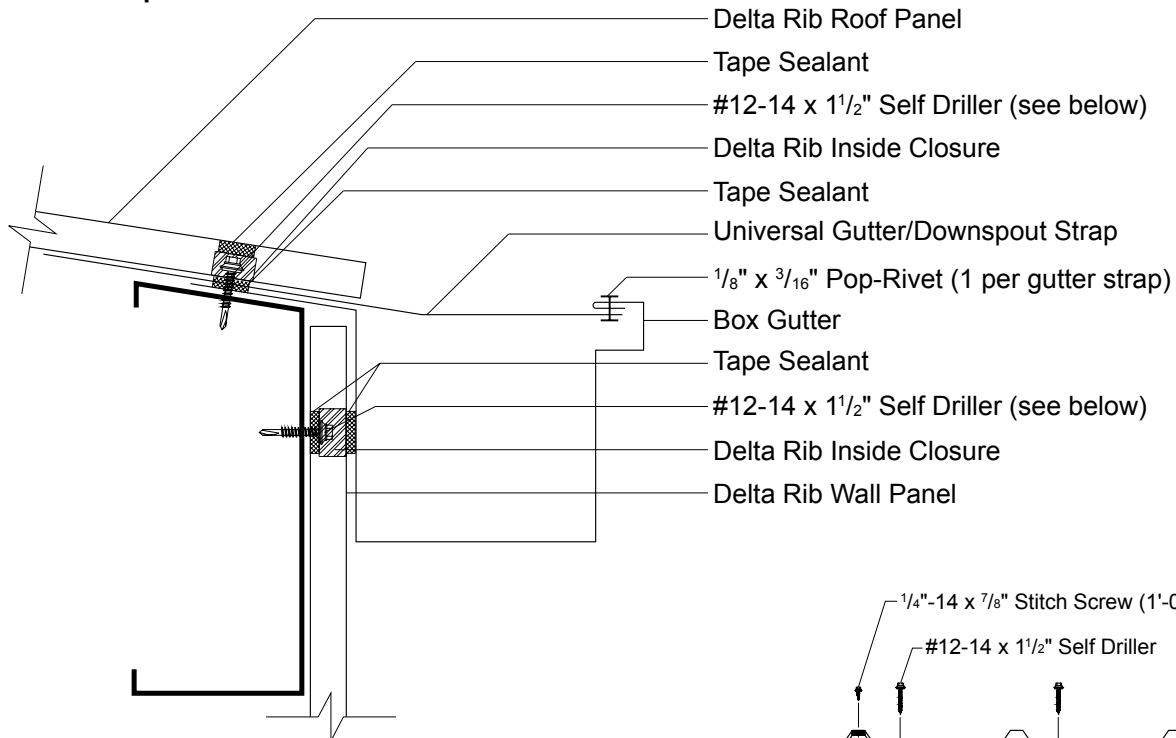

DELTA RIB

VALLEY DETAIL

3:12 Minimum
Roof Slope

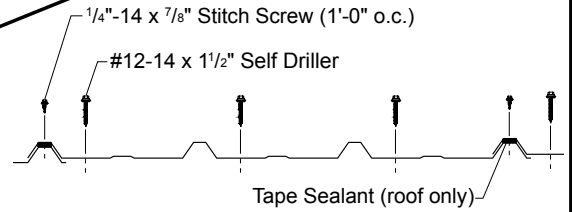
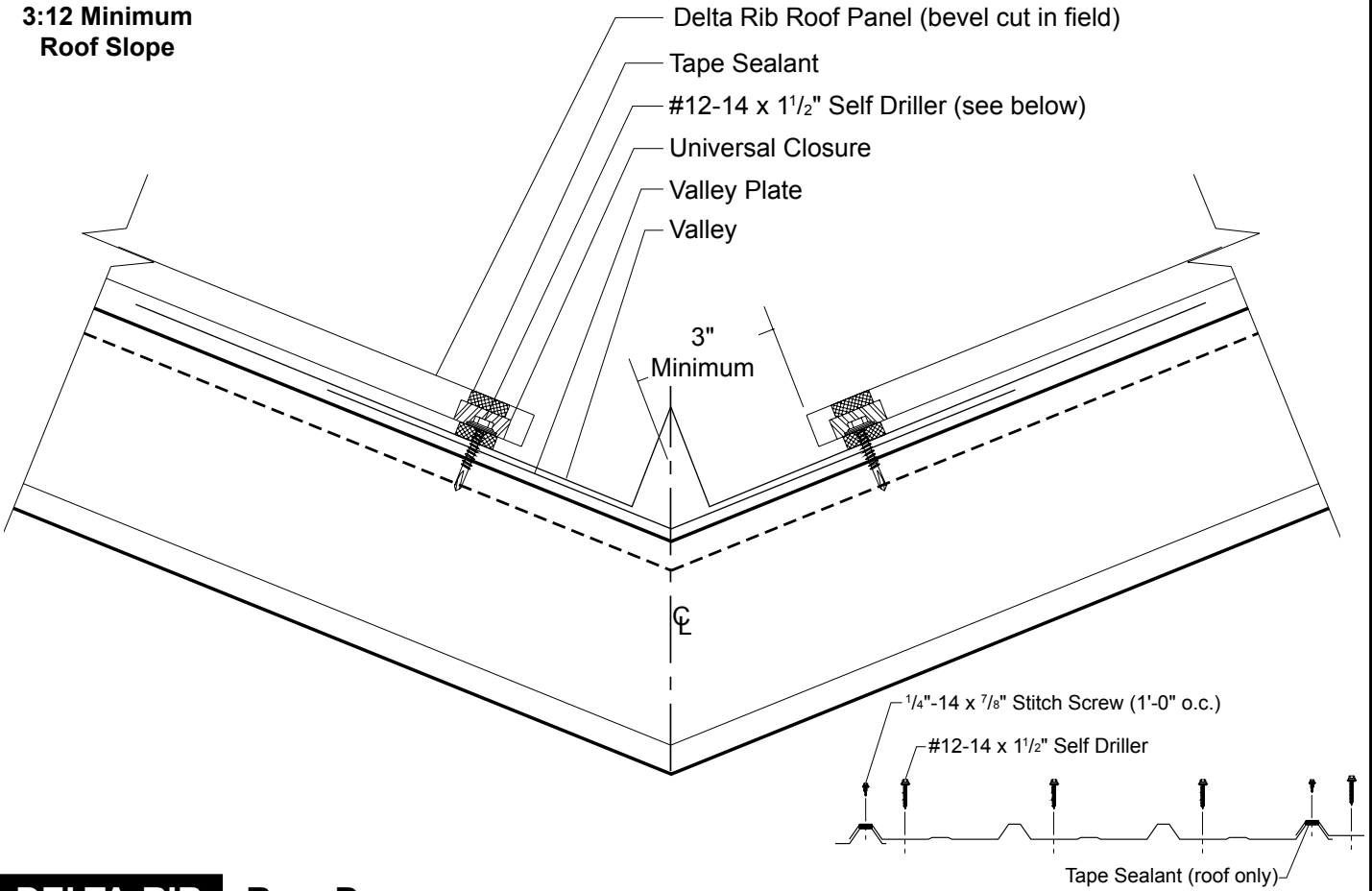

Delta Rib Screw Fastening Pattern

DELTA-RIB

RAKE DETAIL

3:12 Minimum
Roof Slope

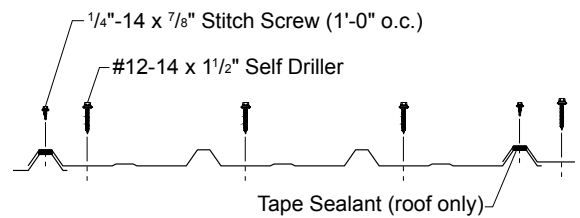
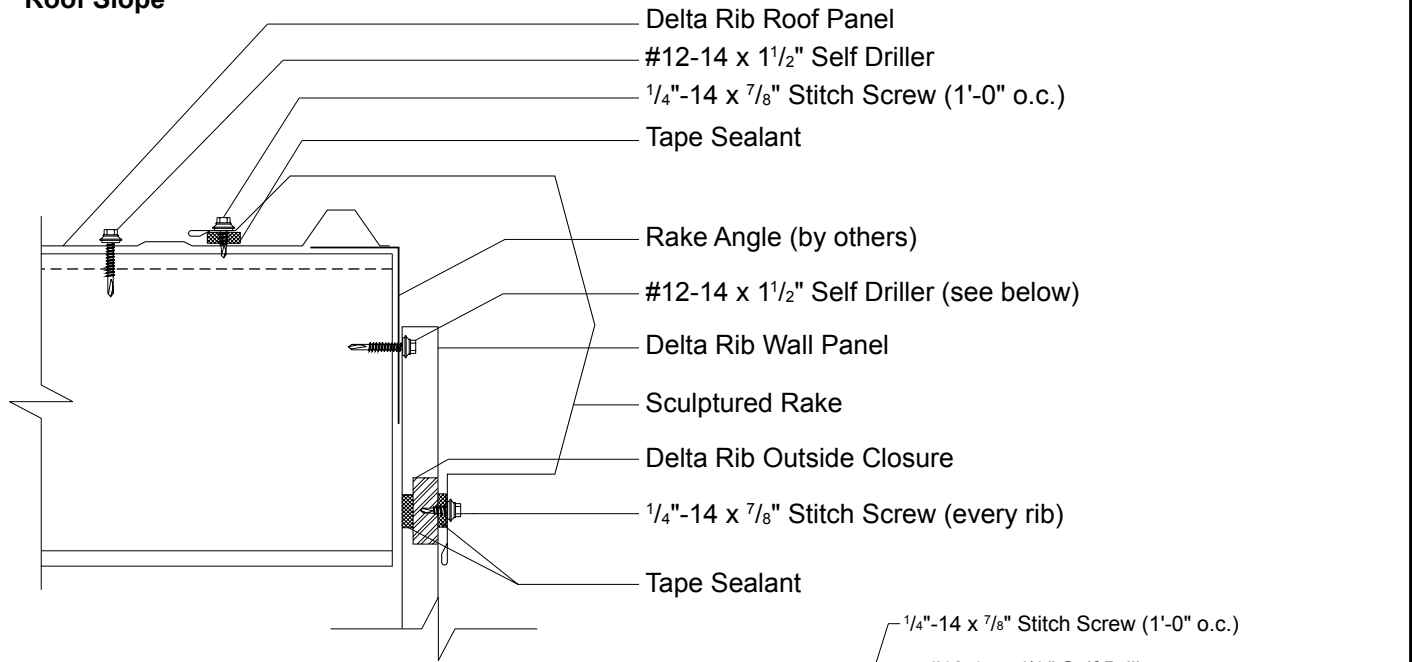

Delta Rib Screw Fastening Pattern

DELTA RIB

RAKEWALL WITH COUNTER FLASHING DETAIL

3:12 Minimum Roof Slope

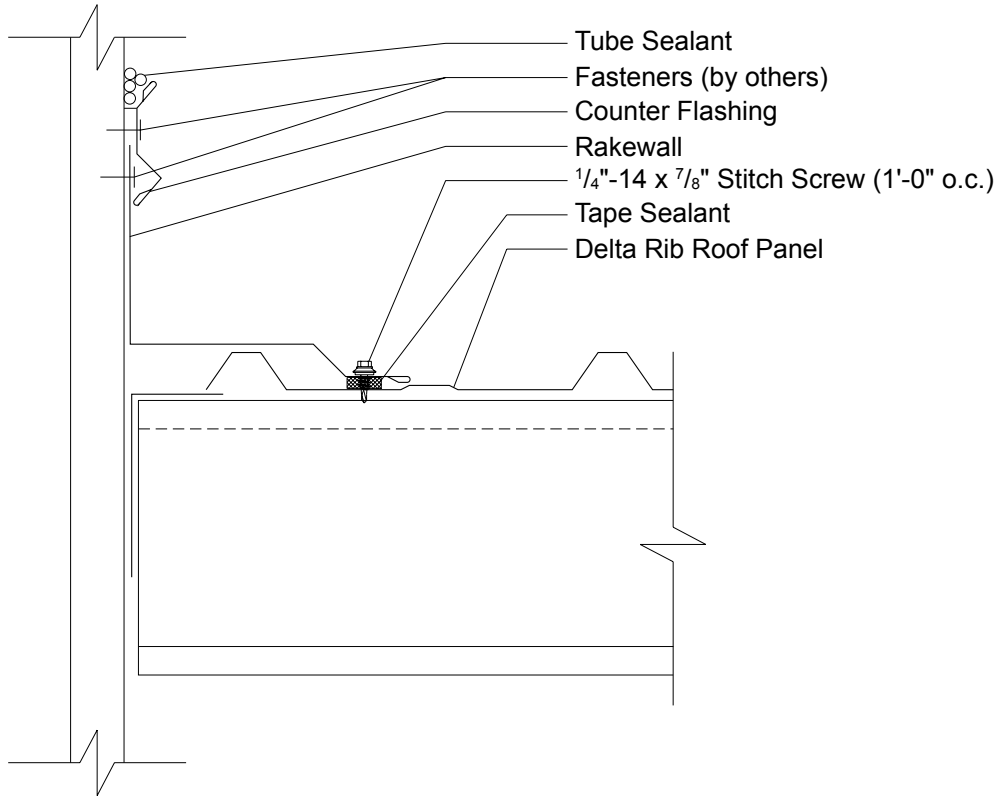

DELTA-RIB

ENDWALL WITH COUNTER FLASHING DETAIL

3:12 Minimum Roof Slope

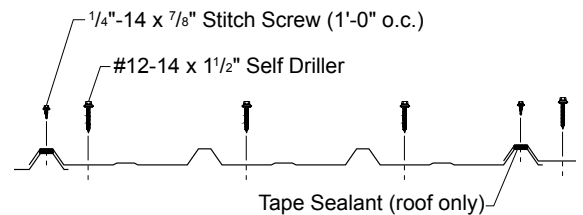
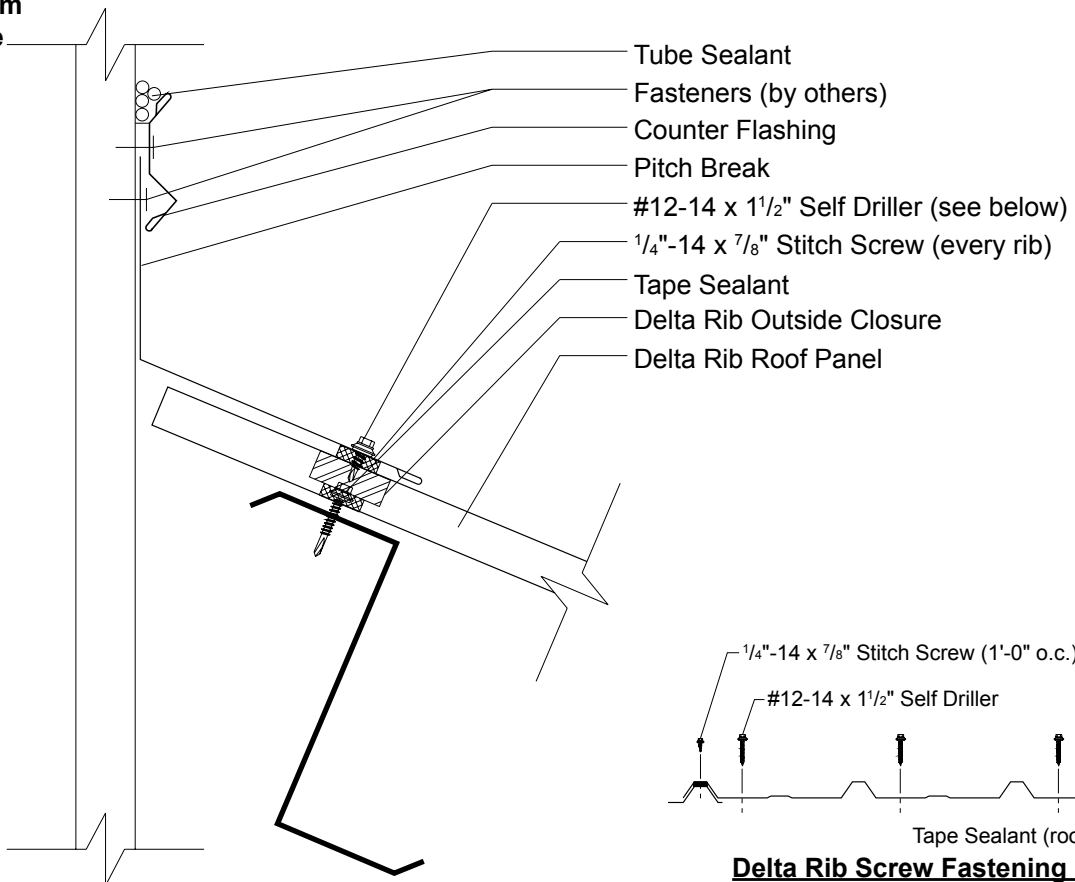

Delta Rib Screw Fastening Pattern

DELTA RIB SCULPTURED HIGH SIDE EAVE DETAIL

3:12 Minimum
Roof Slope

- Delta Rib Roof Panel
- 1/4"-14 x 7/8" Stitch Screw (every rib)
- Tape Sealant
- Delta Rib Outside Closure
- Tape Sealant
- Sculptured High Side Eave
- #12-14 x 1 1/2" Self Driller (see below)

- Tape Sealant
- 1/4"-14 x 7/8" Stitch Screw (every rib)

- Delta Rib Outside Closure
- Delta Rib Wall Panel

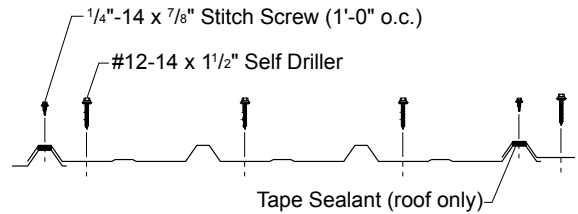

Delta Rib Screw Fastening Pattern

DELTA-RIB RIDGE/HIP DETAIL

3:12 Minimum
Roof Slope

- Delta Rib Roof Panel
- #12-14 x 1 1/2" Self Driller (see below)
- 1/4"-14 x 7/8" Stitch Screw (every rib)
- Tape Sealant
- Outside Closure *
- 20" Ridge/Hip Cover

* For Ridge, use Delta Rib Outside Closure.
For Hip, use Universal Closure.

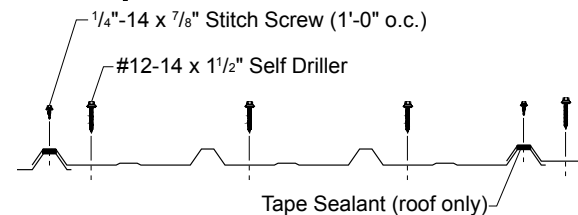

Delta Rib Screw Fastening Pattern

DELTA RIB UNIVERSAL RIDGE DETAIL

3:12 Minimum
Roof Slope

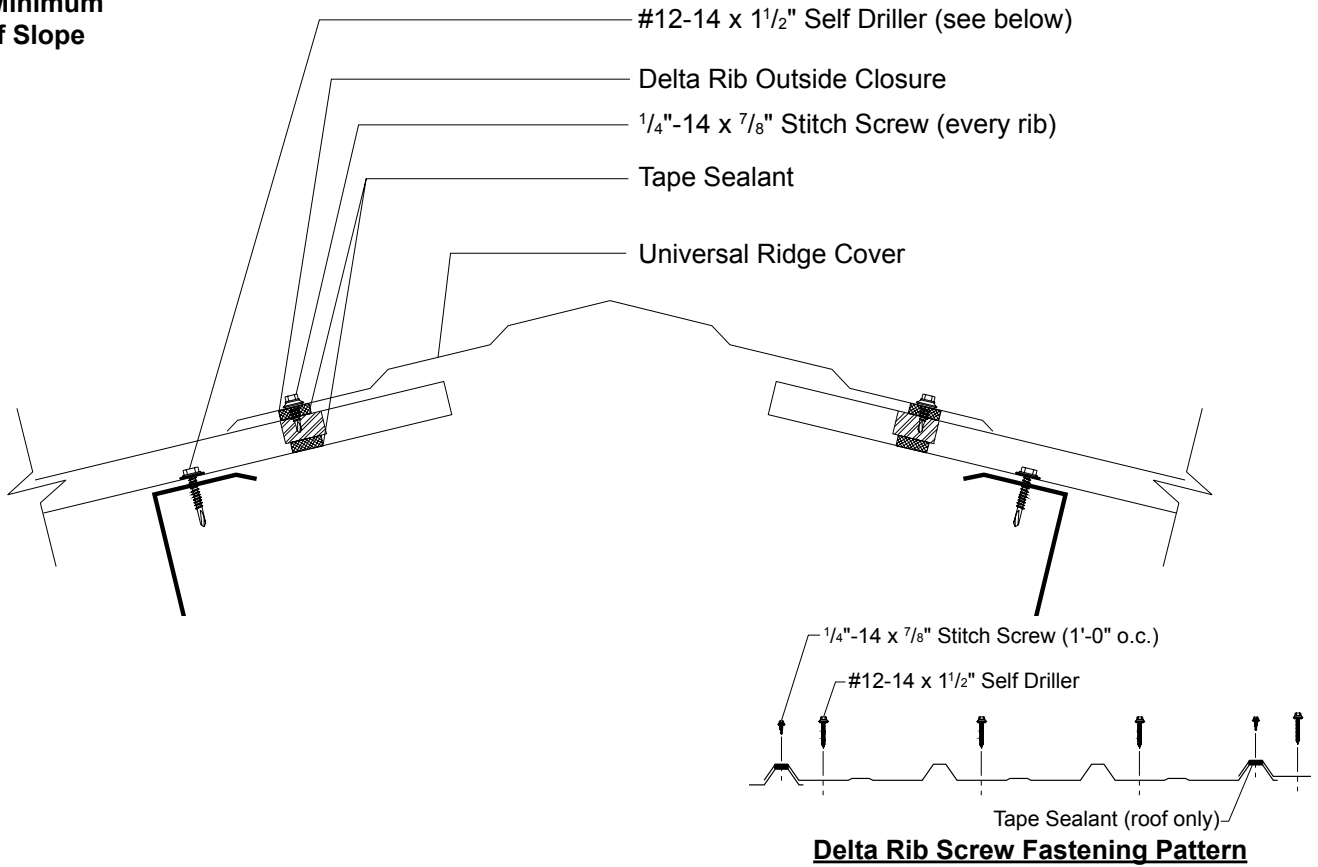

DELTA-RIB GRAVEL STOP DETAIL

3:12 Minimum
Roof Slope

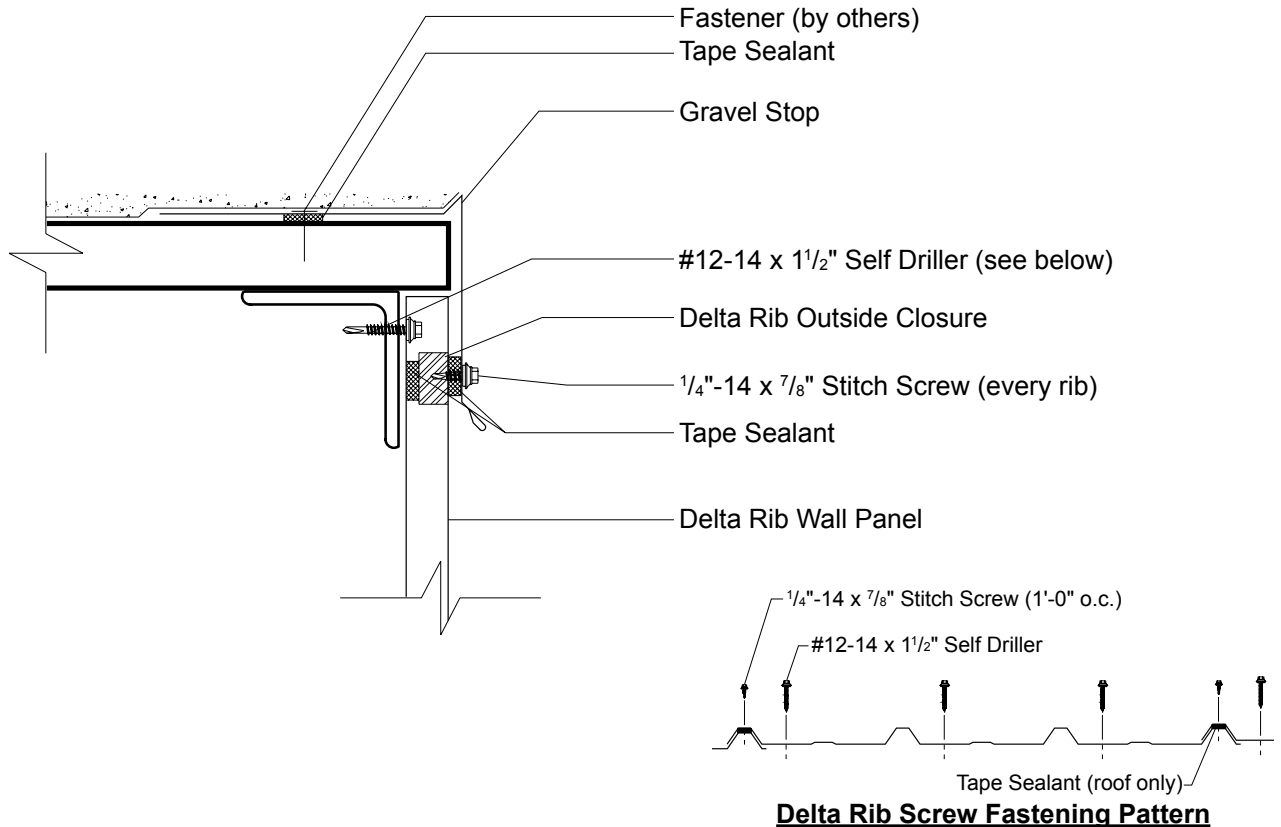

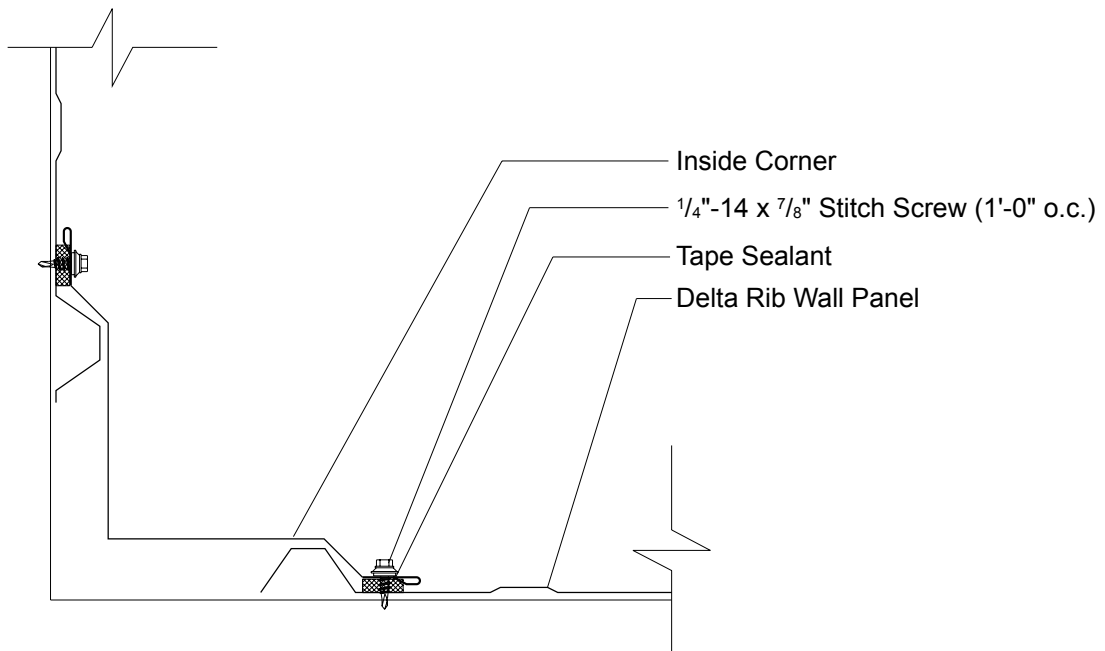
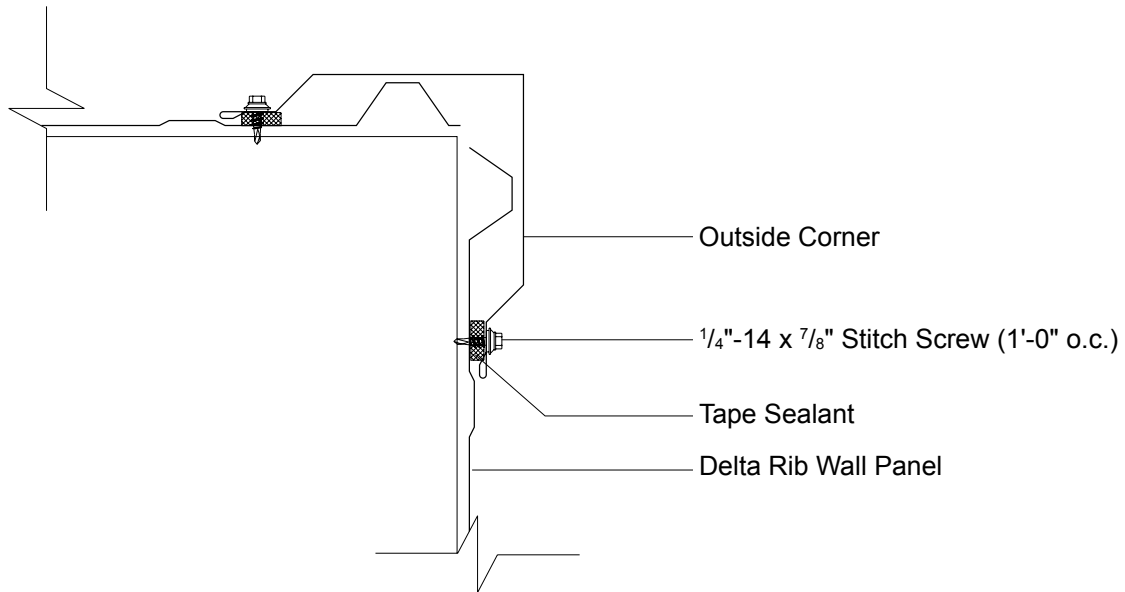

DELTA RIB JAMB DETAIL

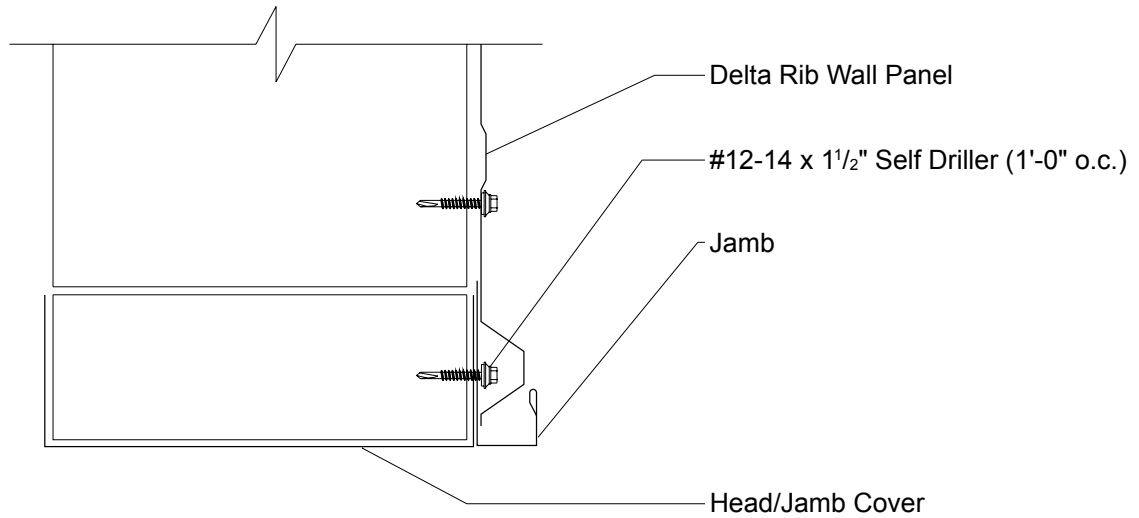

DELTA-RIB HEAD DETAIL

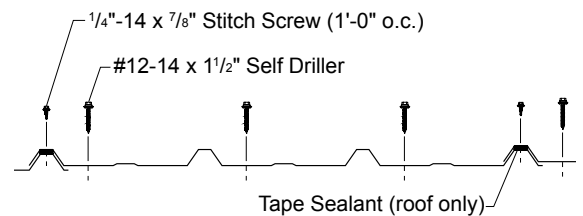
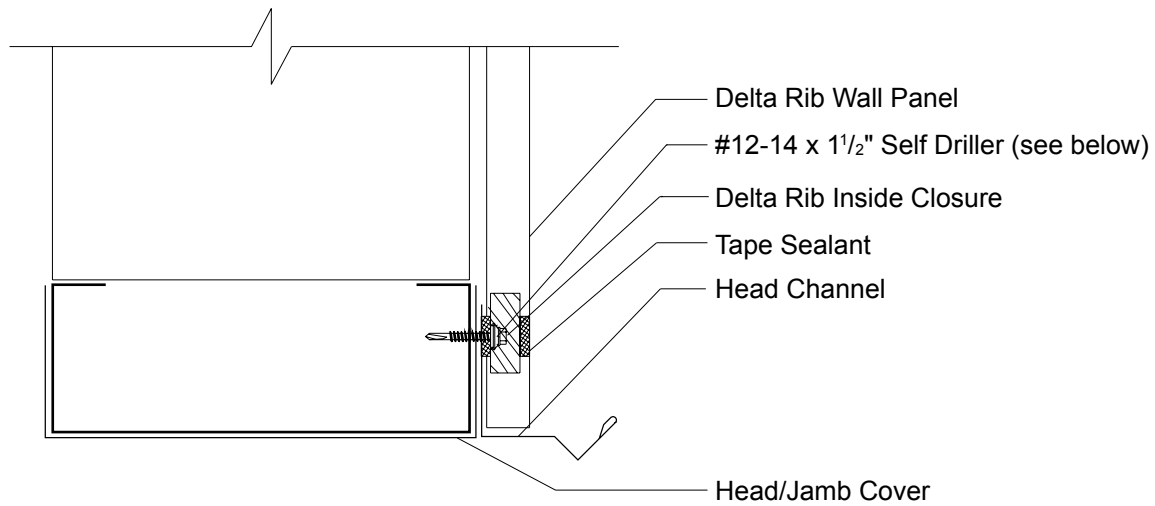

Delta Rib Screw Fastening Pattern

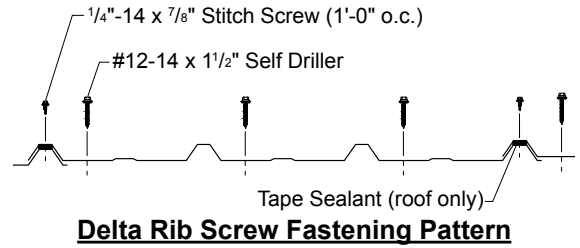
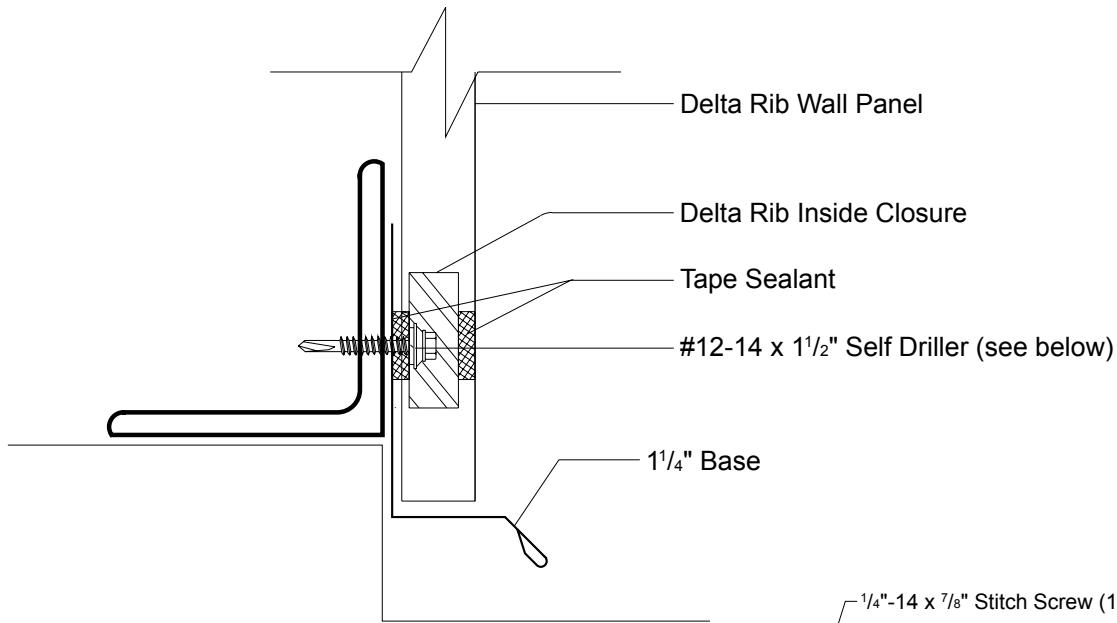

DELTA-RIB

NOTES
