

# Stile

*Your Premium Roofing Source*



*PVDF (Kynar 500) Paint System*

*26 Gauge*



**Spanish Clay** ★

SR = 0.36 | TE = 0.85 | SRI = 38



**Slate Grey** ★

SR = 0.31 | TE = 0.86 | SRI = 31

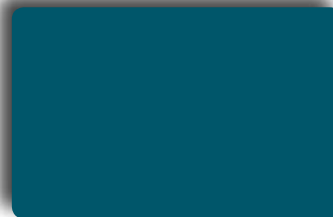

**Ocean Blue** ★

SR = 0.29 | TE = 0.86 | SRI = 29

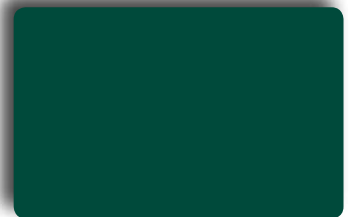

**Classic Green** ★

SR = 0.32 | TE = 0.86 | SRI = 33



**Regal Red** ★

SR = 0.34 | TE = 0.86 | SRI = 31

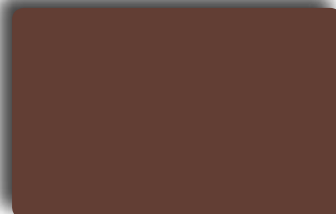

**Tudor Brown** ★

SR = 0.32 | TE = 0.86 | SRI = 33

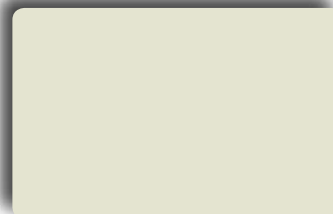

**White** ★

SR = 0.63 | TE = 0.86 | SRI = 75



★ Meets or Exceeds Steep Slope Energy Star Requirements

## GENERAL INFORMATION

Stile is a metal roofing system designed to be durable while simulating the elegant look of clay roofing tiles. Panels are attached with fasteners coated to match the panel finish and placed in the shadow line of the panel step. A full line of architectural and formed flashings as well as accessories are available for typical roof conditions.

### Specify Stile metal roofing for...

- The architectural look of clay tile
- Cost effective, easy installation of panels
- The light-weight benefits of steel
- A coverage width of 39.4" (1 meter)
- Panel lengths from 3'-0" to 20'-0"
- 26 gauge galvanized (G90) steel
- A selection of rich colors in PVDF (Kynar 500) finish
- A 45-Year limited warranty on the paint finish

### Testing

- UL 790, Class A Fire Rating
- UL 2218, Class 4 Impact Resistance
- Miami-Dade County Approved (08-0229.11)
- Florida Building Code approved (8131.4, 9107.4, 10916.5)
- UL 580 Class 90 Wind Uplift (Construction No. 533 over 5/8" plywood deck)
- Texas Windstorm Evaluation R-163

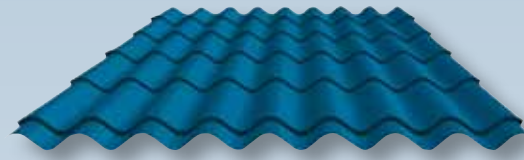

### Slope

The minimum recommended slope for Stile roof panel is 3:12.

### Substructure

The recommended substrate is 5/8" plywood with a 30# felt moisture barrier. To avoid panel distortion, use a properly aligned and uniform substructure.

*Note: Stile roof panels are not recommended for use over open framing.*

### Coverage

Each panel has a coverage of 39.4" (1 meter).

### Length

Minimum factory cut length is 3'-0".

Maximum panel length is 20'-0".

Lengths from 3'-0" to 20'-0" are available in 1'-0" increments.

### Fasteners

The fastener selection guide should be consulted for choosing proper fastener for specific applications. Quantity and type of fastener must meet necessary loading and code requirements (see Stile Installation Guide).

### Endlaps

For panel runs over 20'-0" an endlap is required. Stile panel endlap is 4".

## FLASHING AND PANEL INFORMATION

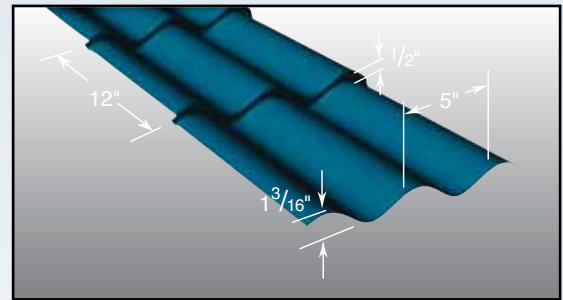
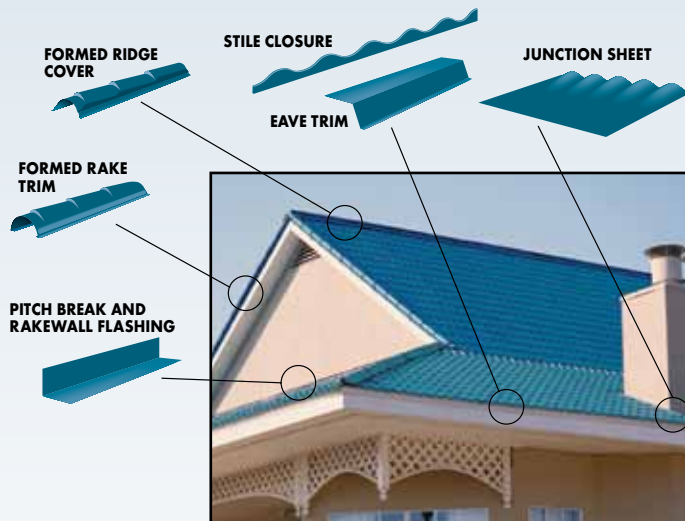

*Standard details and installation instructions for the Stile panel are available upon request or can be downloaded from the Metal Sales web site. Please contact your local branch for pricing information.*

[www.metalsales.us.com](http://www.metalsales.us.com)



Longmont, CO: 800.289.7663  
Jacksonville, FL: 800.394.4419  
Jefferson, OH: 800.321.5833  
Independence, MO: 800.747.0012  
Sellersburg, IN: 800.999.7777  
Rogers, MN: 800.328.9316

Antioch, TN: 800.251.8508  
Spokane, WA: 800.572.6565  
Kent, WA: 800.431.3470  
Rock Island, IL: 800.747.1206  
Orwigsburg, PA: 800.544.2577  
Temple, TX: 800.543.4415

Woodland, CA: 800.759.6019  
Fontana, CA: 800.782.7953  
Anchorage, AK: 866.640.7663  
Bay City, MI: 888.777.7640  
Detroit Lakes, MN: 888.594.1394  
Mocksville, NC: 800.228.6119  
Fort Smith, AR: 479.646.1176